

Min alfabetmappe



Navn:

Fyld bogstaverne ud med
flotte mønstre og farver

Aa

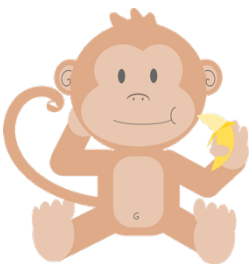
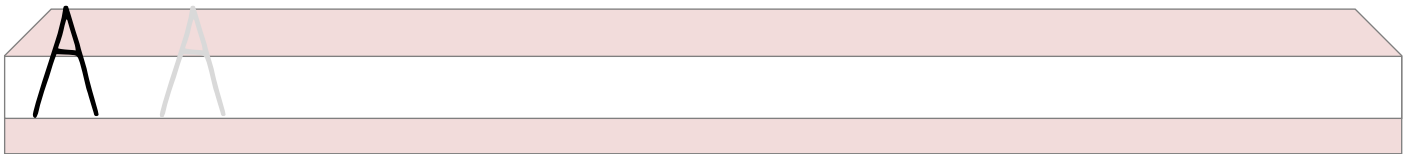
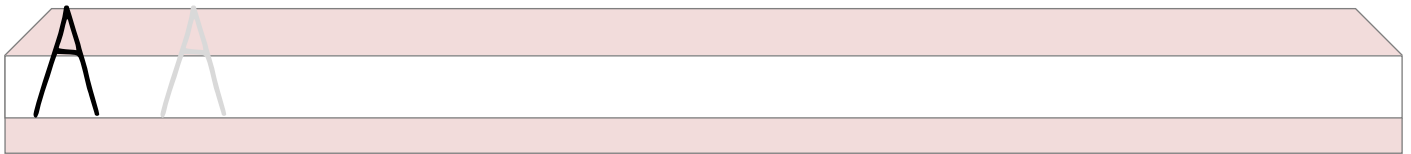
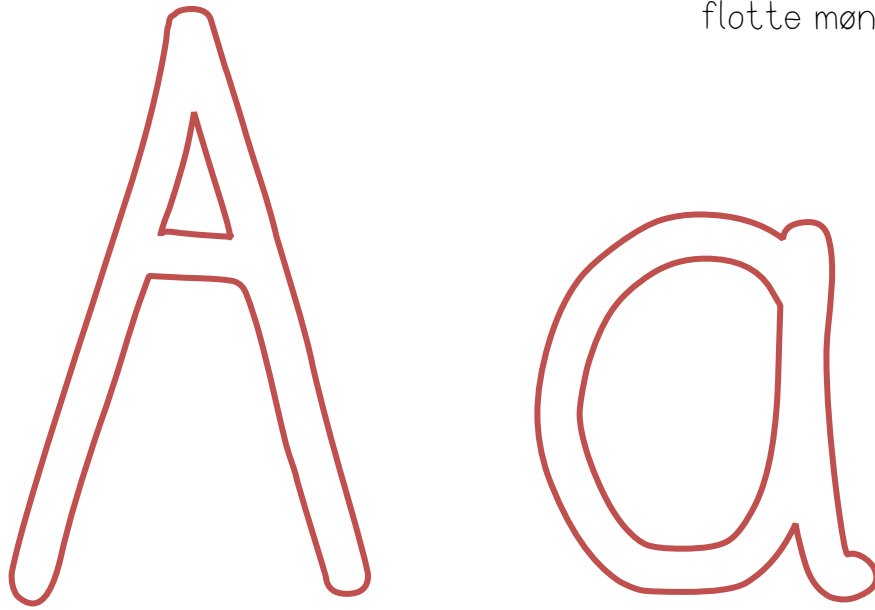

abe



ananas

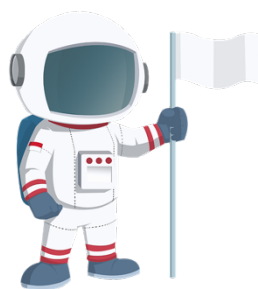

astronaut



avis



appelsin

Find A'erne i rækken af bogstaver. Sæt ring om dem.

k l a y a t a r ø n m a f h w a

A W P A L Ø A M C S D F A H

a u o å u a æ e a u d a o g u a

A U Å V A N V Æ R Å A Æ Å N

Hvad starter med A? Skriv eller tegn i kassen.



Hvad starter med A? Sæt ring om billedet.

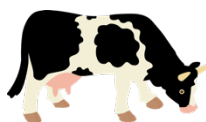
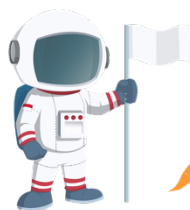

Hvor mange stavelser er der i ordet? Sæt kryds.



abe

1 2 3 4



ananas

1 2 3 4



agurk

1 2 3 4



and

1 2 3 4



appelsin

1 2 3 4



avis

1 2 3 4



anker

1 2 3 4

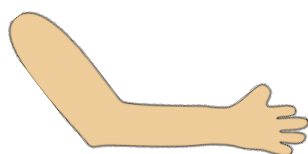

arm

1 2 3 4

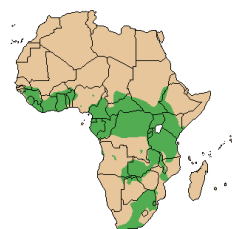

Afrika

1 2 3 4

Bb

Fyld bogstaverne ud med
flotte mønstre og farver.

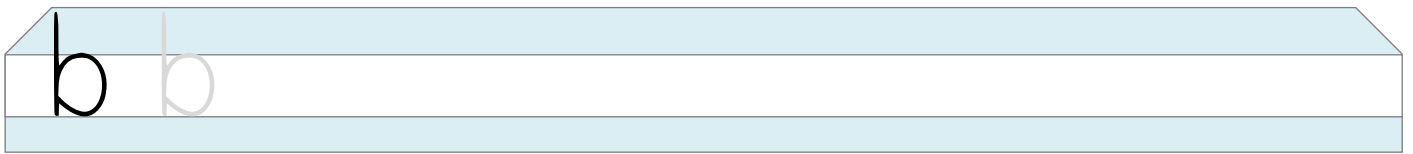
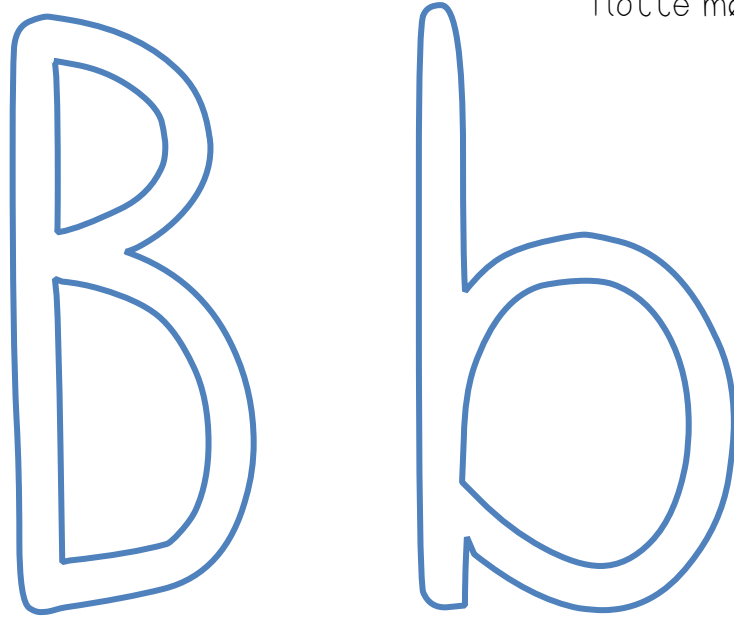

bil

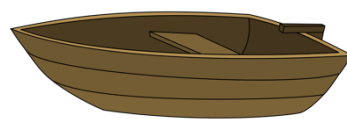

båd



bi



banan



bus

Find B'erne i rækken af bogstaver. Sæt ring om dem.

i n b f b g h w b å a j b o s b

B K L M B G E B S D B Q Å B N

p b d a u b p d r d b a b p d u

R B D P B F R P B P B D R B P

Hvad starter med B? Skriv eller tegn i kassen.

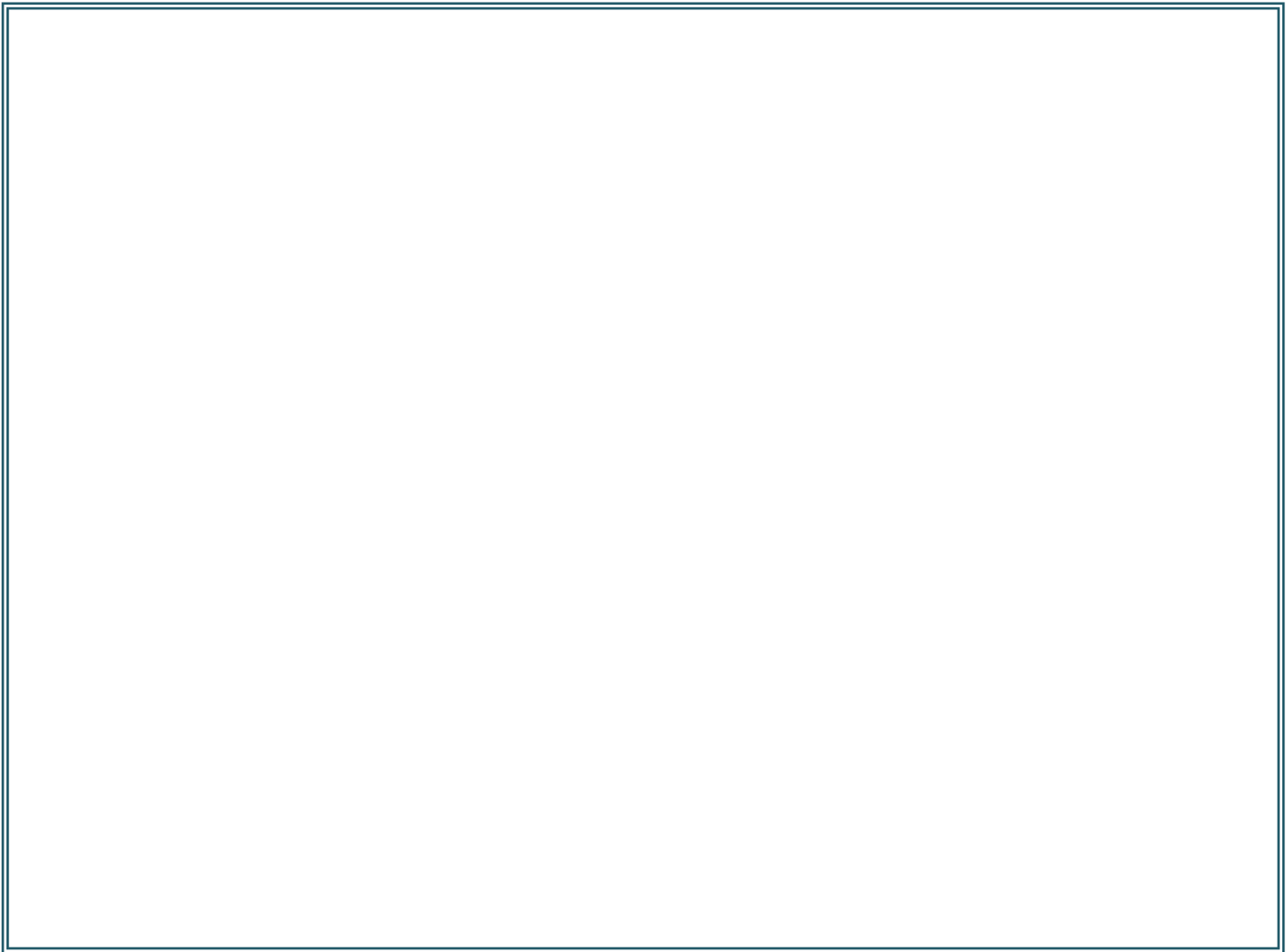

Sæt streg fra billedet til det rigtige ord.



banan



bus

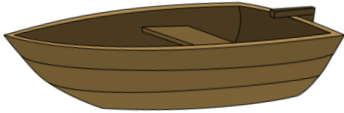

bil



blomst

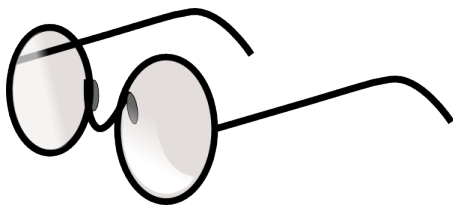

båd



brille



bæver

Cc

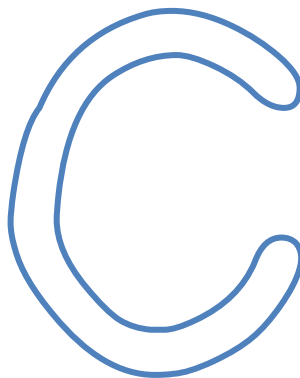

Fyld bogstaverne ud med
flotte mønstre og farver.

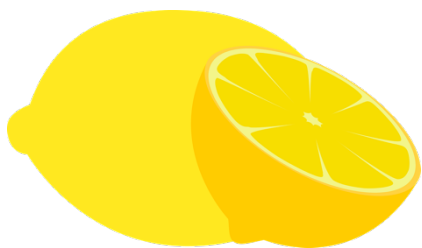
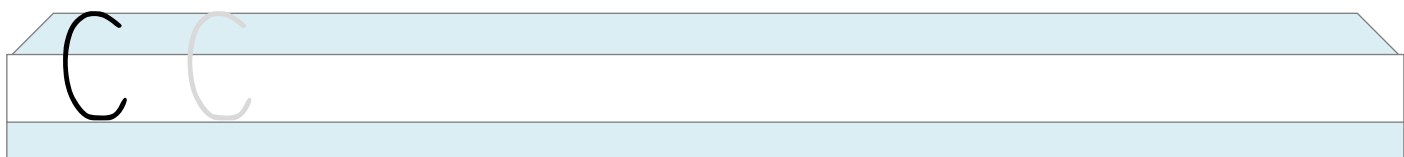

citron



cirkus



cykel

Find C'erne i rækken af bogstaver. Sæt ring om dem.

f c g h c t v c u n c p c l k w l

C F G H C B M C S X C P V C P

a c å u o c a o d c x c a c u o

C G Ø Q G C O C U G C Q O C

Hvad starter med C? Skriv eller tegn i kassen.



Dd

Fyld bogstaverne ud med
flotte mønstre og farver.

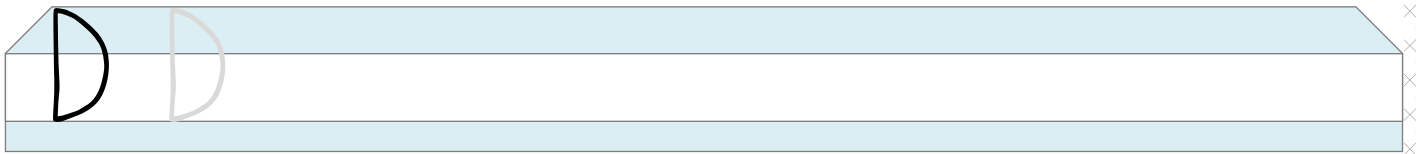
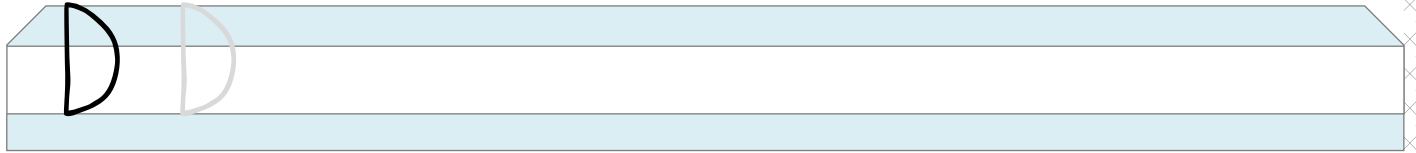
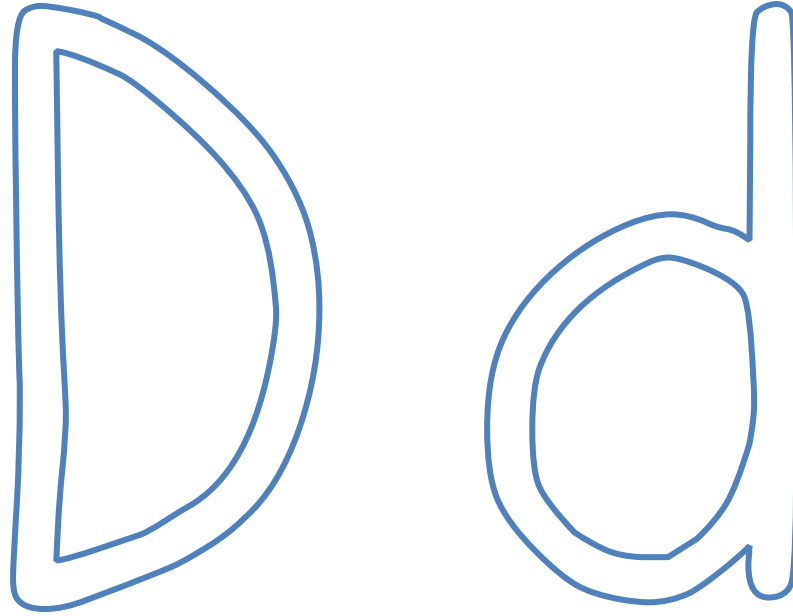

due



dinosaurus



diamant



delfin

Find D'erne i rækken af bogstaver. Sæt ring om dem.

d g e o d l d q p å d n m d a ø

F D G H D M L D P Q Å D Ø D

b d a b p d b d u a b d p d b p

D R P B D B O B D P O D P R O

Hvad starter med D? Skriv eller tegn i kassen.

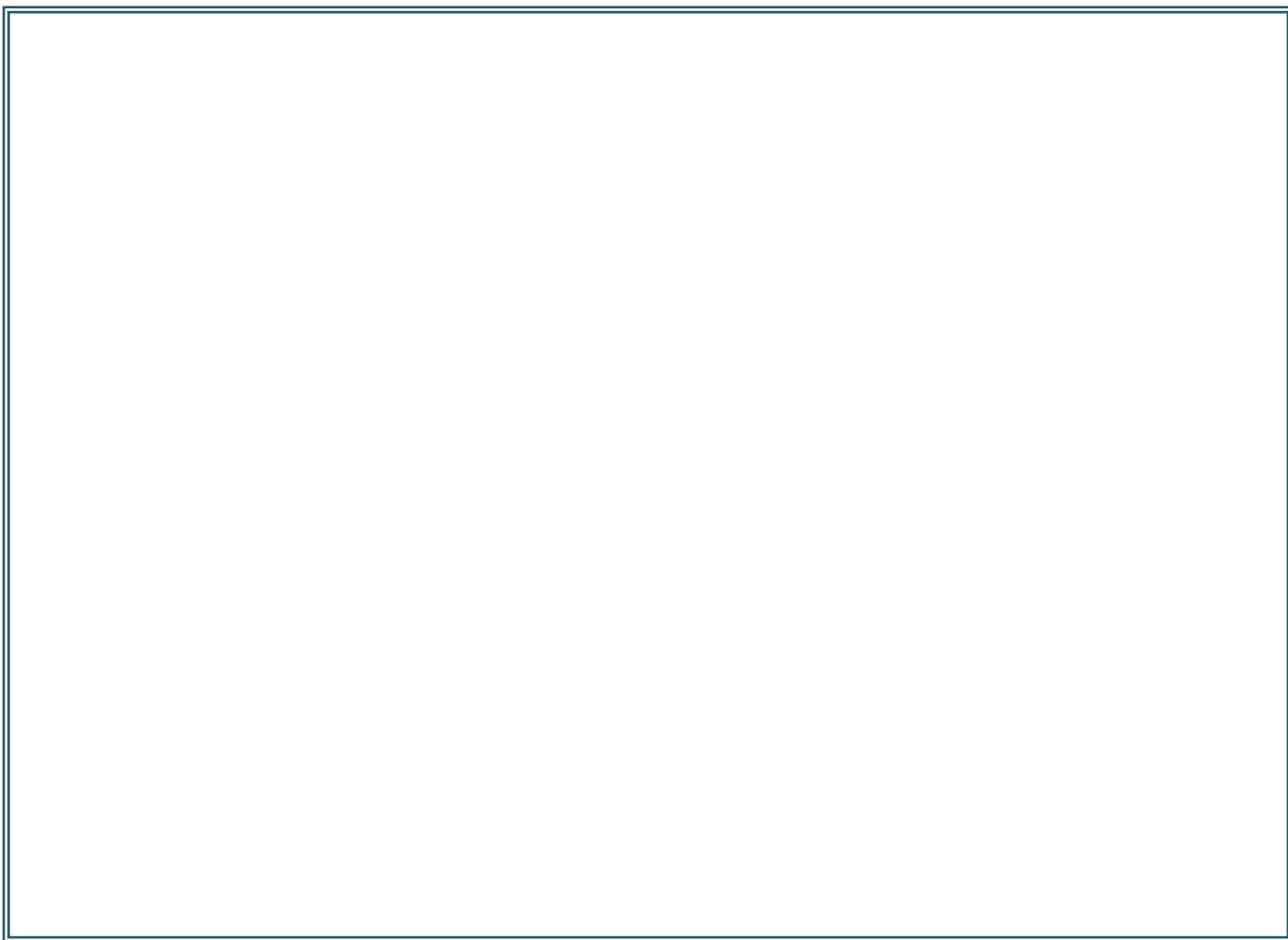

Hvad starter med D? Sæt ring om billedet.



Hvor mange stavelser er der i ordet? Sæt kryds.



dukke

1 2 3 4



delfin

1 2 3 4



dåse

1 2 3 4



dør

1 2 3 4



due

1 2 3 4



drue

1 2 3 4



diamant

1 2 3 4



dame

1 2 3 4



Danmark

1 2 3 4

Ee

E

e

Fyld bogstaverne ud med
flotte mønstre og farver.

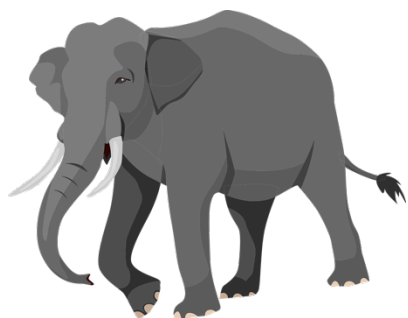
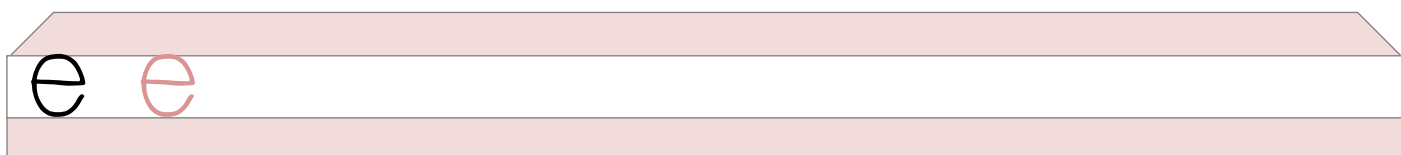
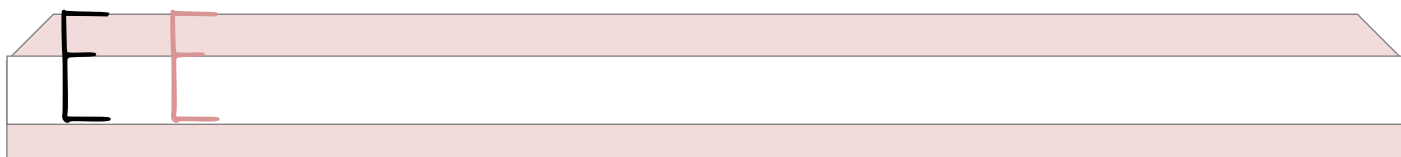
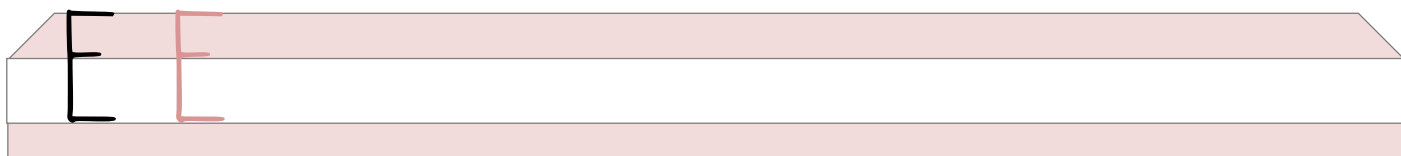

elefant



engel



egern

Find E'erne i rækken af bogstaver. Sat ring om dem.

e f g e t b k e l ø e p s d t e

T E K B E L Ø O P E Q N E M

o e a c e å d e g c e a e c a å

E H B E T P D B E H E L Æ E Æ

Hvad starter med E? Skriv eller tegn i kassen.



Farv de billeder, der starter med E.

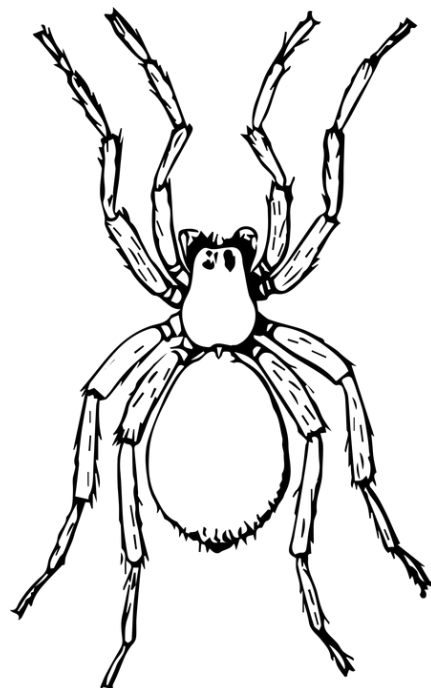
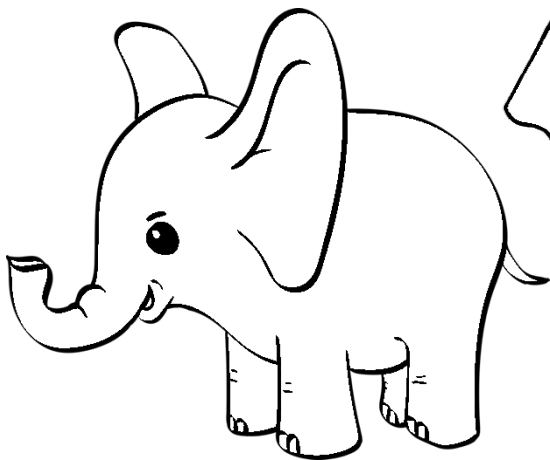
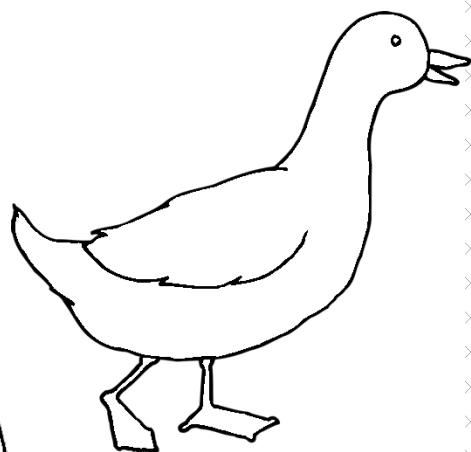
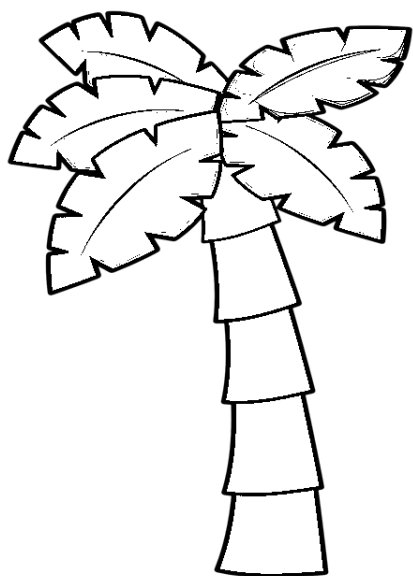

Ff

Fyld bogstaverne ud med
flotte mønstre og farver.

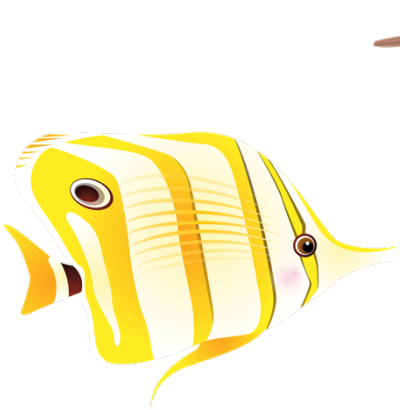
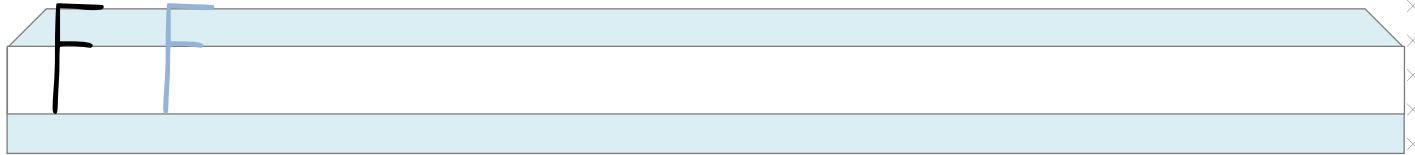
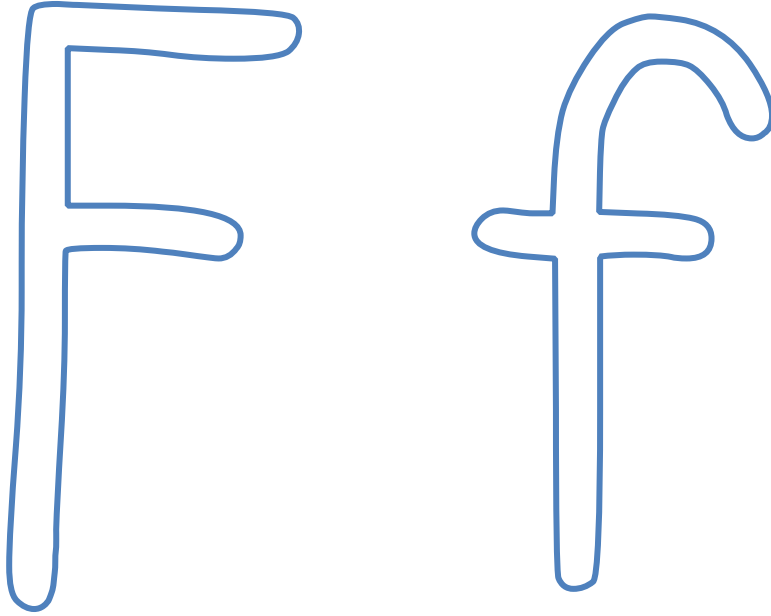

fisk

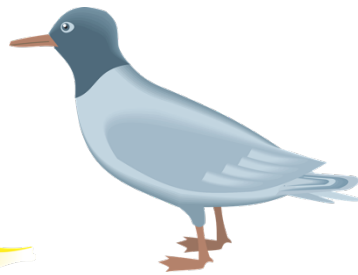

fugl



frø



fjernsyn

Find F'erne i rækken af bogstaver. Sæt ring om dem.

f g h f k v b f e a f a p f l å ø



















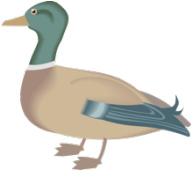

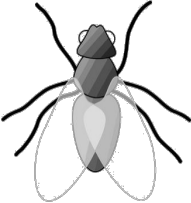









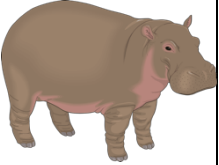

F U M G F V C S A F V F Å L F

t f l k t f f p b d t f j k h f h

E F T P R E F E P T P F E P E T

Hvad starter med F? Skriv eller tegn i kassen.

Find vej fra start til slut. Du må kun gå på ord, der starter med F.

| | | | | | |
|---|---|---|--|---|---|
| Start → |  |  |  |  |  |
|  |  |  |  |  |  |
|  |  |  |  |  |  |
|  |  |  |  |  |  |
|  |  |  |  |  |  |
|  |  |  |  |  | Slut |

Hvor mange stavelser er der i ordet? Sæt kryds.



fjernsyn

- 1
- 2
- 3
- 4

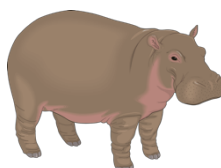

flodhest

- 1
- 2
- 3
- 4



får

- 1
- 2
- 3
- 4

Gg

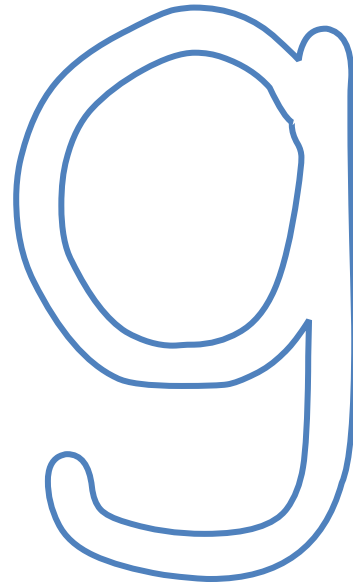

Fyld bogstaverne ud med
flotte mønstre og farver.

G G

G G

g g

g g

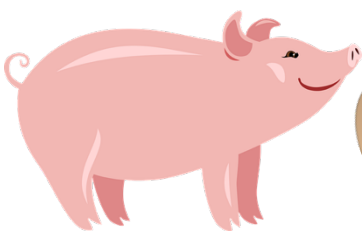

gris



guitar



gave

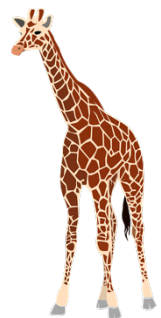

giraf

Find G'erne i rækken af bogstaver. Sæt ring om dem.

t h g b g s k g l a g p å d g ø

G M L Æ G K P Å G V G N M L P

j y g p g a u g a y p g j a j g

C O G U G C Ø O G C O C G C

Hvad starter med G? Skriv eller tegn i kassen.

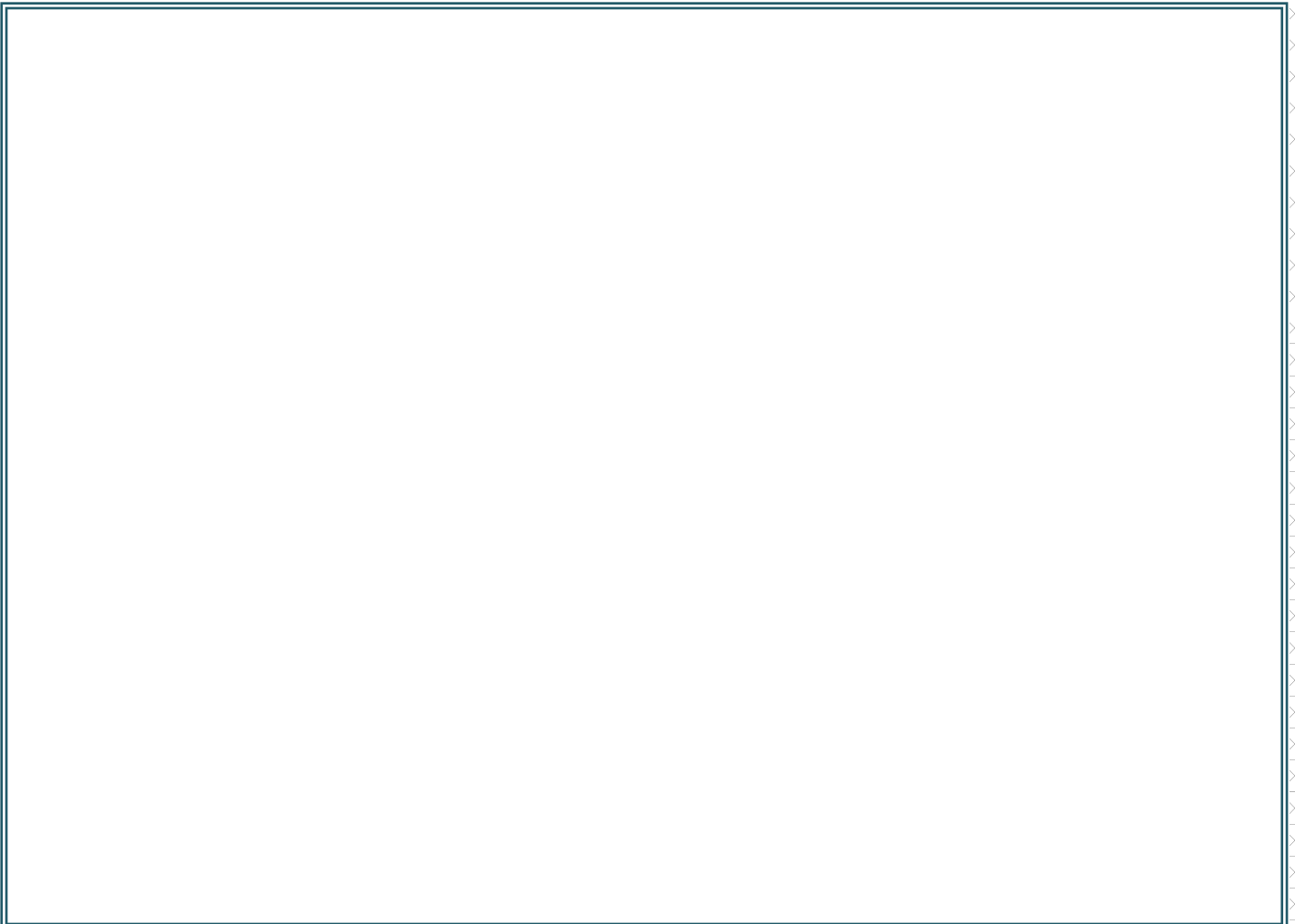

Hvad starter med G? Sæt ring om billedet.



Sæt streg fra billedet til det rigtige ord.



ged



giraf



gave



gris



gulerod

Hh

Fyld bogstaverne ud med
flotte mønstre og farver.

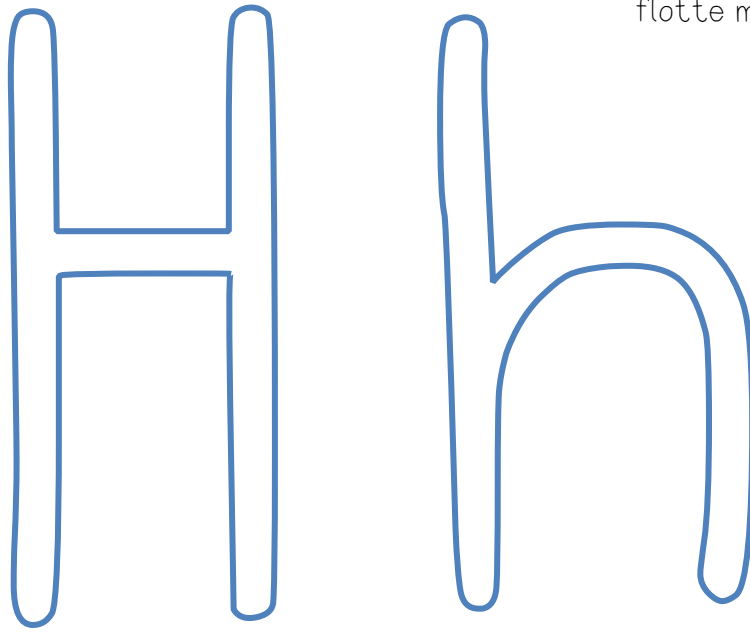

helikopter



hund



haj

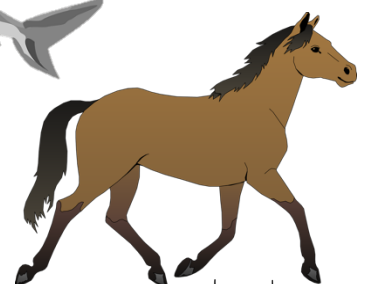

hest

Find H'erne i rækken af bogstaver. Sæt ring om dem.

g h j m h p å h ø l h j k e a h

Ø O H M H W H Å Ø O H K J H

k h f b d h d b h p a h b d h l

H T E F H K L B H A K E H J H

Hvad starter med H? Skriv eller tegn i kassen.



Farv de billeder, der starter med H.

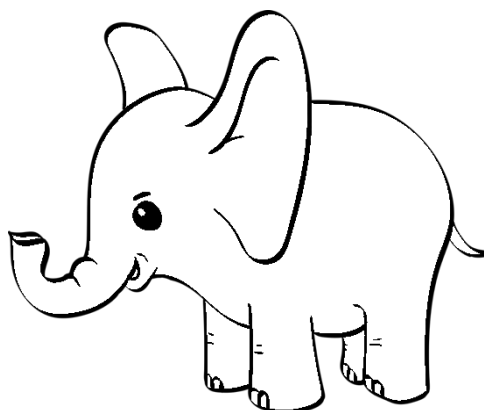
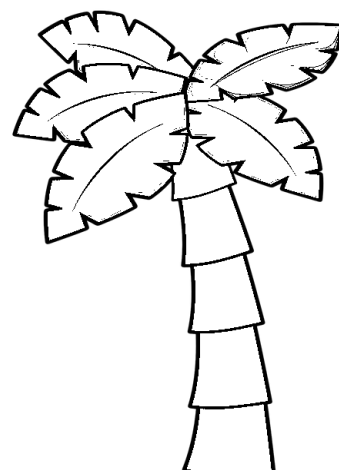
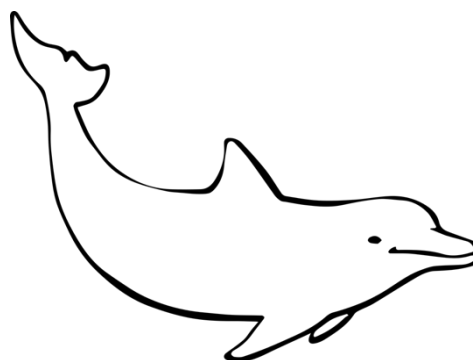
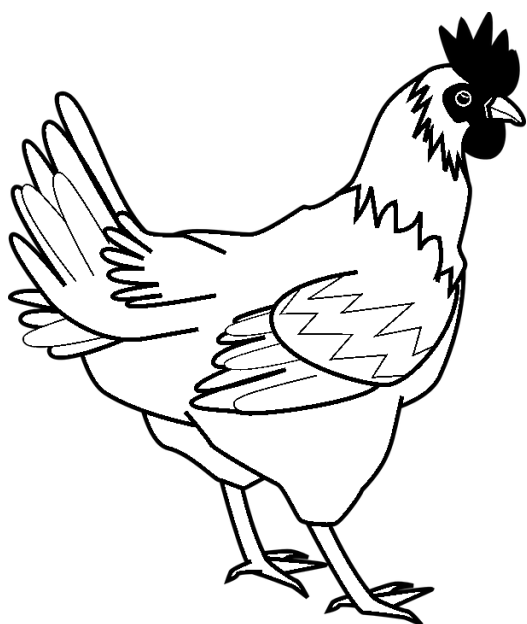
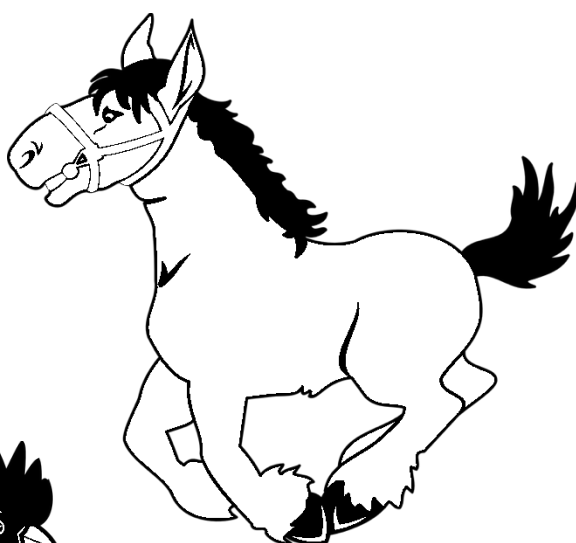
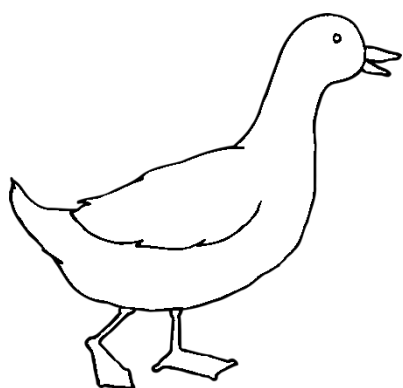

Ii

Fyld bogstaverne ud med
flotte mønstre og farver.

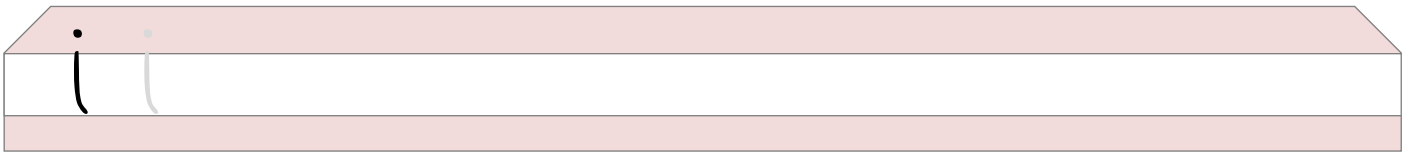
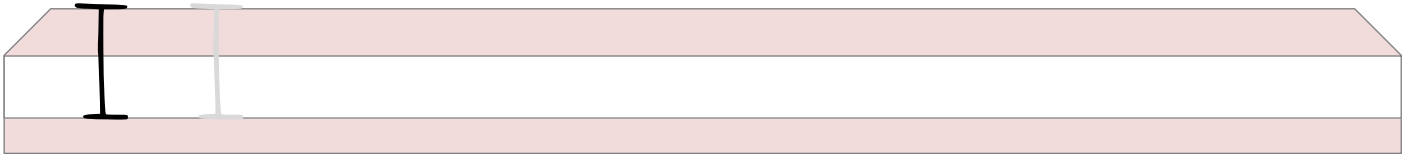
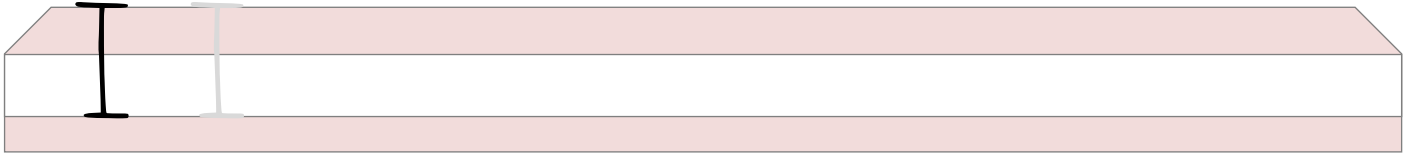
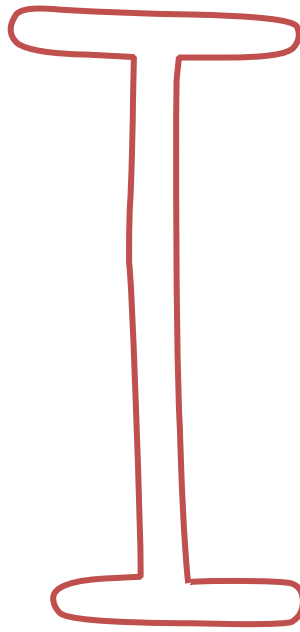

is

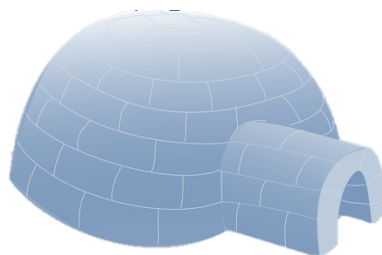

iglo

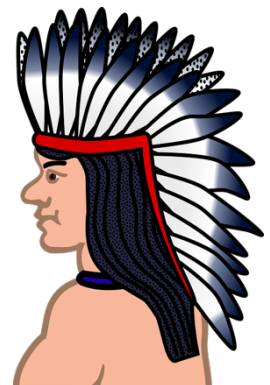

indianer

Find I'erne i rækken af bogstaver. Sæt ring om dem.

u h i o k l m n o p i p i ø a i

A S I K L I P I O T G N I Æ I

i u j t l i j i å l y å j i u n i j l

I L T I E L P I T I T P E Y I T

Hvad starter med I? Skriv eller tegn i kassen.



Hvor mange stavelser er der i ordet? Sæt kryds.

is

1 2 3 4

isbjørn

1 2 3 4

iglo

1 2 3 4

Skriv det rigtige ord i kassen og sæt ring om det rigtige billede.

i + s =



b + i =



t + i =

10



b + i + l =



v + i + n =

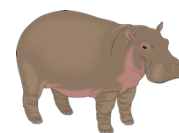

s + k + i =

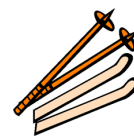

r + i + s =



J j

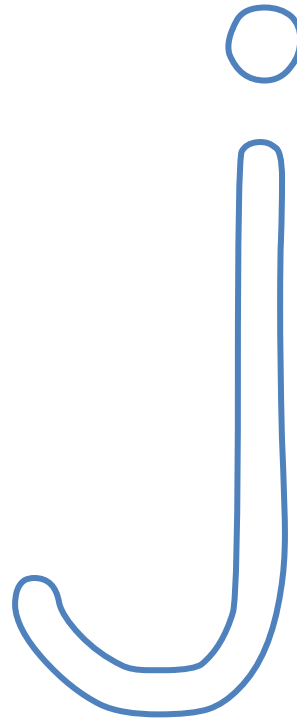
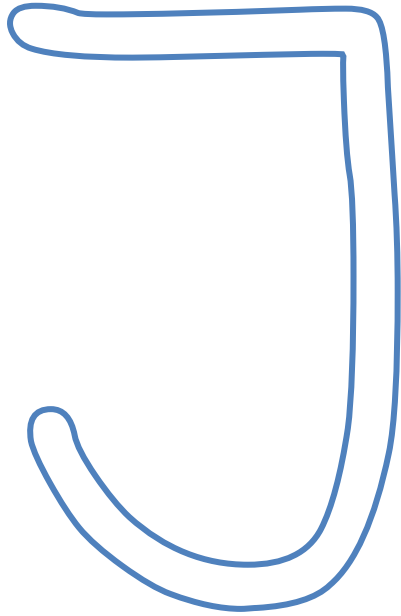

Fyld
bogstaverne
ud med
flotte
mønstre og
farver.

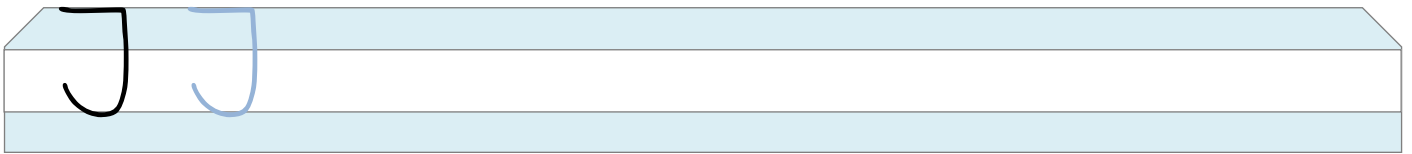

juletra



jordbar



jakke

Find J'erne i rækken af bogstaver. Sat ring om dem.

n m j h y j a e r l j k p j l b m

K J L Æ Q A J M P J K Å J Ø T

y j i g j i g j i u g i j i g å i j

U L J C J I T J L C L J U I J I

Hvad starter med J? Skriv eller tegn i kassen.

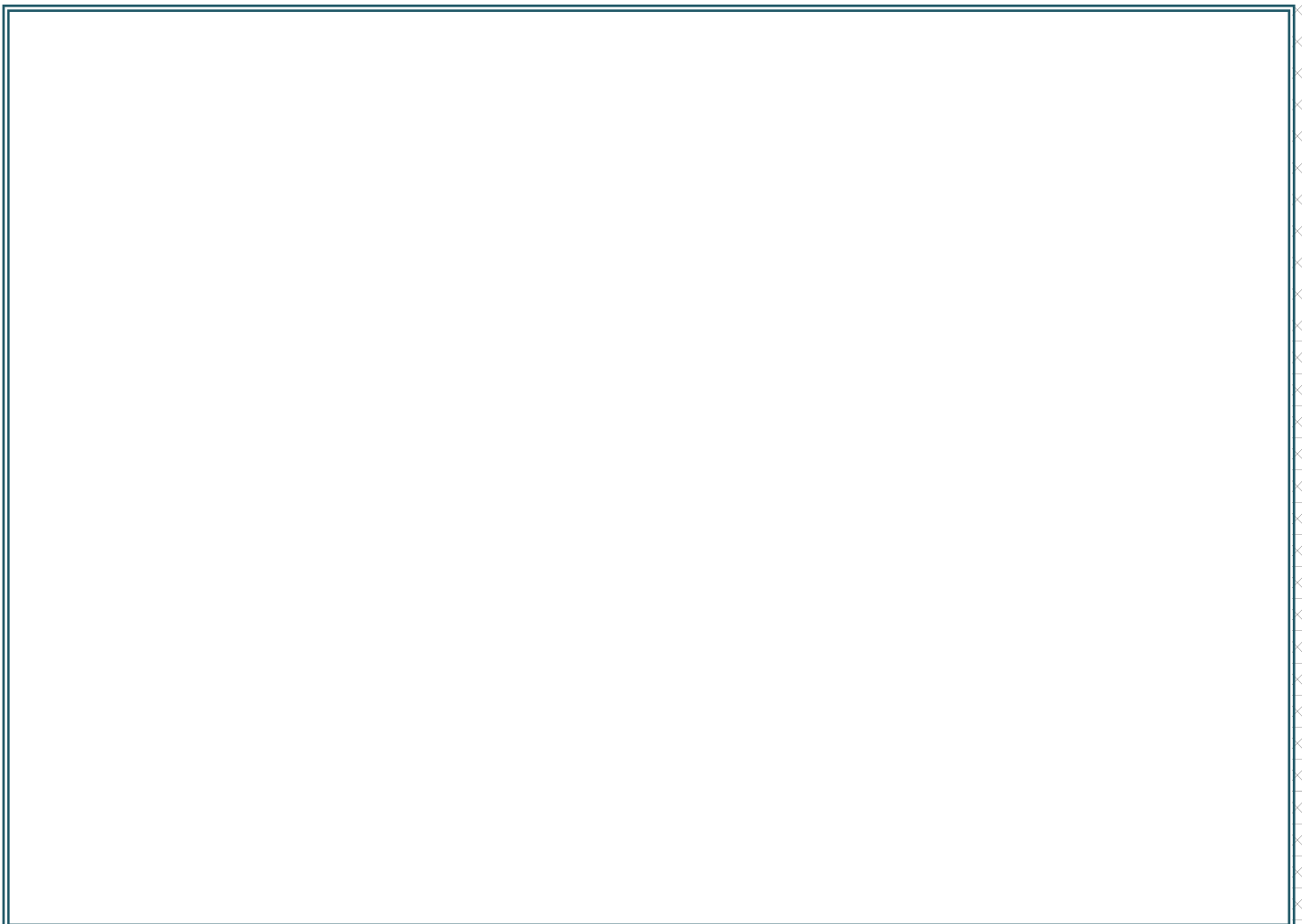

Kk

Fyld bogstaverne ud med
flotte mønstre og farver.

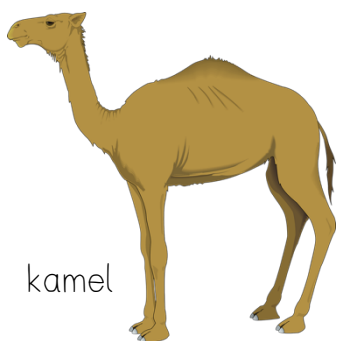
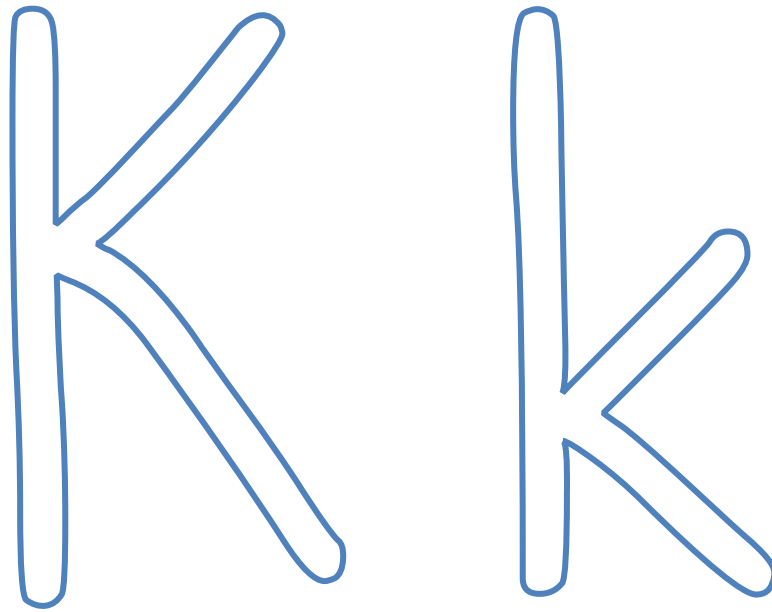

kamel



kasket



kanin



kat

Find K'erne i rækken af bogstaver. Sæt ring om dem.

n b k l k e r k å k a v b k j g

S K O L E P Å K U K N K M K I T

h b k v l k h x b h k h b d h d

X K L H K R K P K R D X P R K

Hvad starter med K? Skriv eller tegn i kassen.

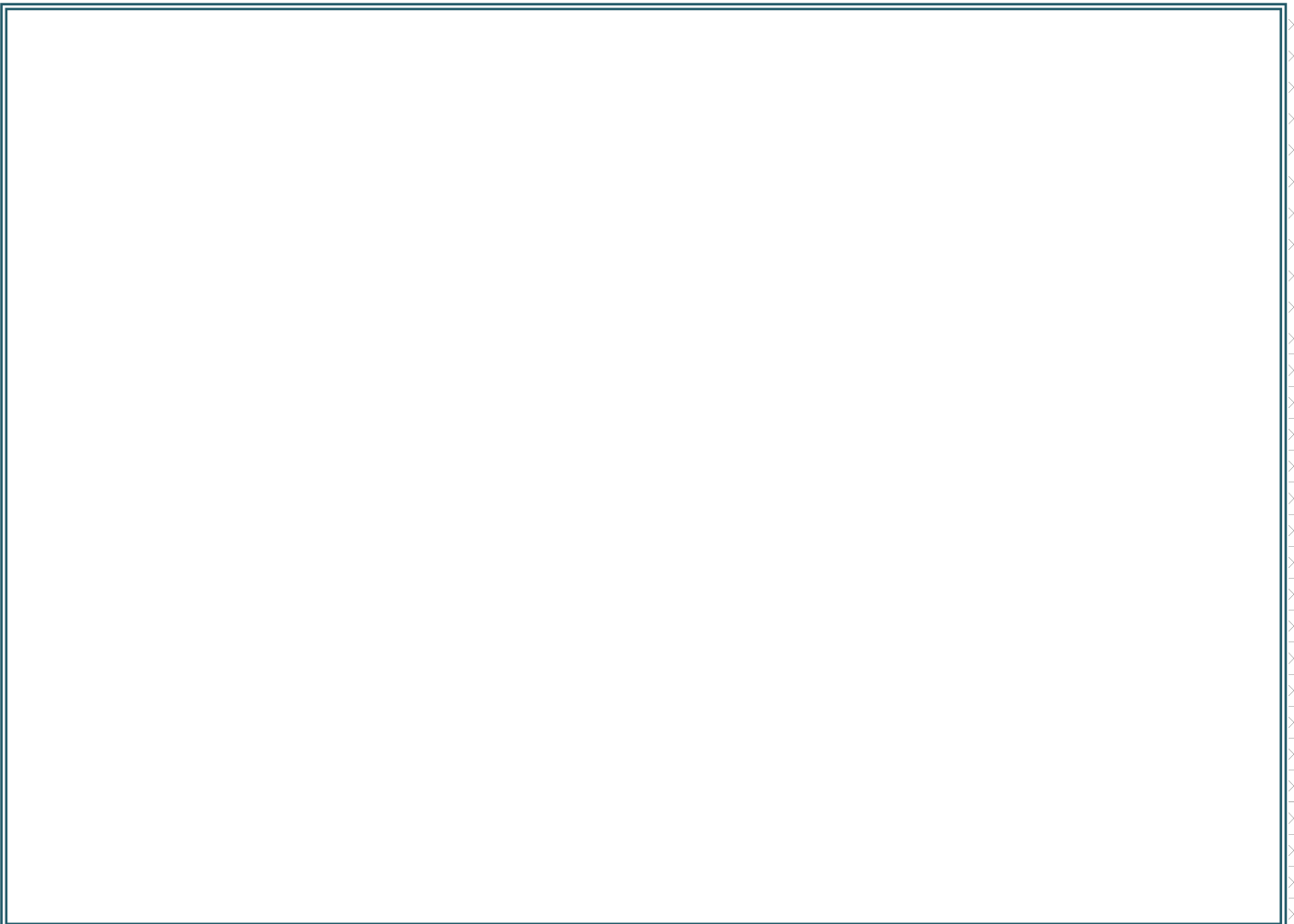

Skriv det ordet i kassen og sæt ring om det rigtige billede.

$k + o = \square$

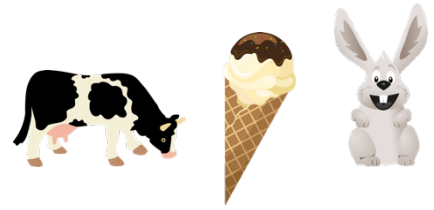

$k + a + t = \square$



$s + k + y = \square$



$s + k + o = \square$



$k + a + m = \square$



$k + y + s = \square$



$k + o + k = \square$



$s + o + k = \square$

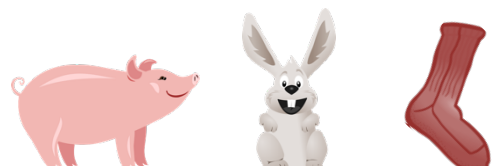

Ll

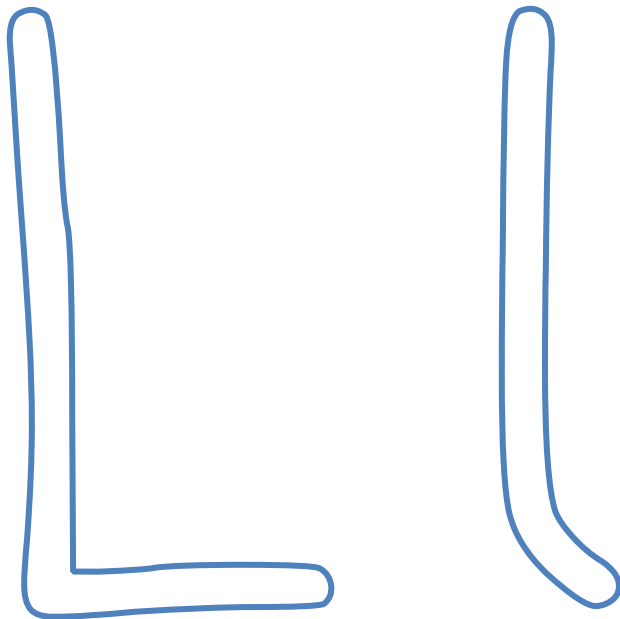

Fyld bogstaverne ud med
flotte mønstre og farver.



lampe



lastbil



lås

Find L'erne i rækken af bogstaver. Sæt ring om dem.

k m l g t l y p ø b l f c l a w l

T Y L K M Ø L V F L O P G L U













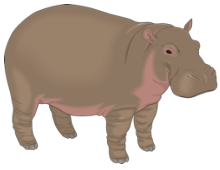













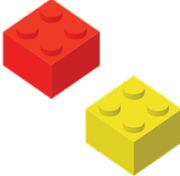
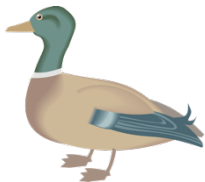
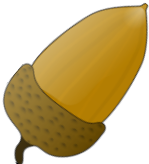

i l j k t l i k l i t l b t p t l i j

L J T I L E F L P Z L J L I T L

Hvad starter med L? Skriv eller tegn i kassen.



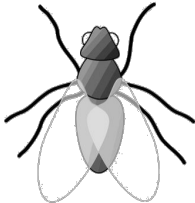

Find vej fra start til slut. Du må kun gå på ord, der starter med L.

| | | | | | |
|---|---|---|--|---|---|
| Start  |  |  |  |  |  |
|  |  |  |  |  |  |
|  |  |  |  |  |  |
|  |  |  |  |  |  |
|  |  |  |  |  |  |
|  |  |  |  |  | Slut |

Hvor mange store og små L'er kan du finde? Skriv det i kassen.

Lille Lise, lille Lise
 fik en hue rød.
 Holdt så meget af den,
 sov med den om natten.
 Lille Lise, lille Lise
 fik en hue rød





Mm

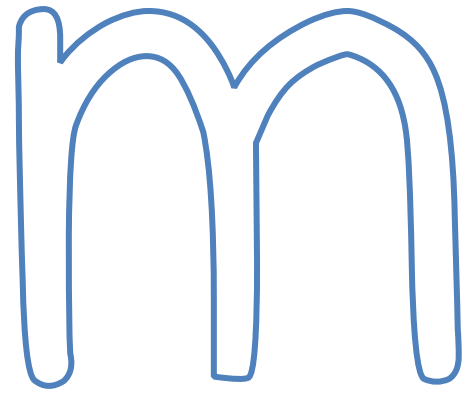
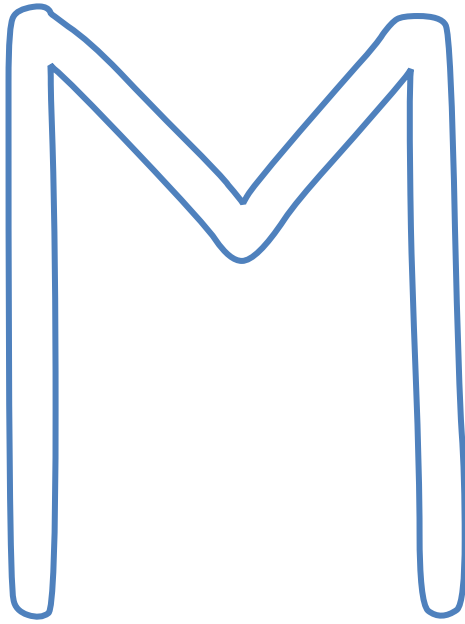

Fyld bogstaverne ud med
flotte mønstre og farver.

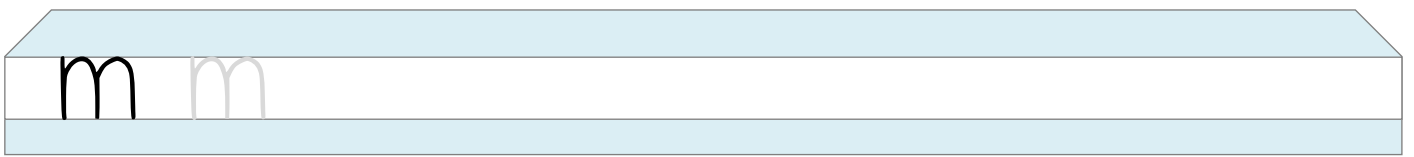
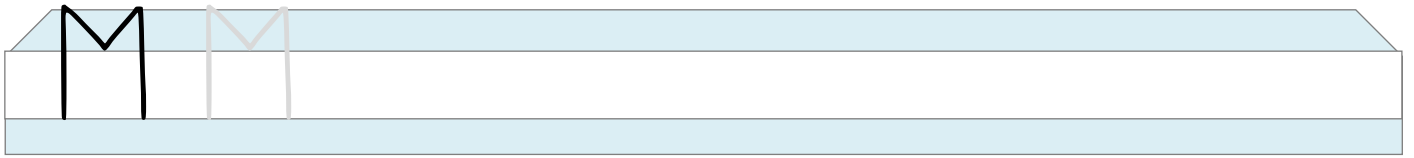

mikrofon

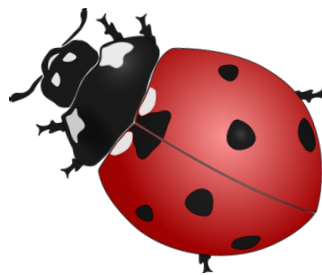

mariehøne

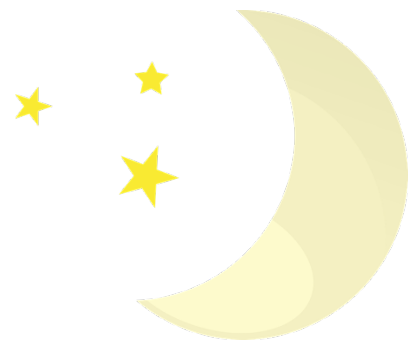

måne

Find M'erne i rækken af bogstaver. Sat ring om dem.

o l m j m g h e r t m b g h m p

T K M L B V M Å L M K A S M S

n m u o m n m u o a n m n u m

N M V W M V W M N M W V M

Hvad starter med M? Skriv eller tegn i kassen.



Farv de billeder, der starter med M.

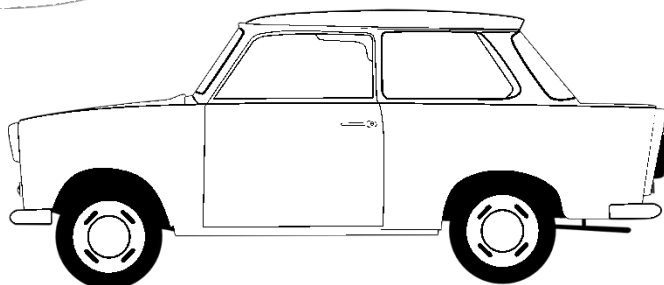
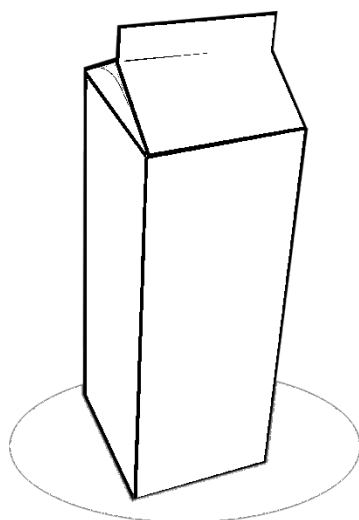
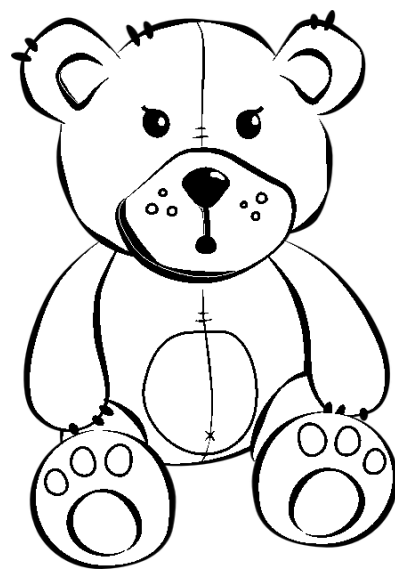
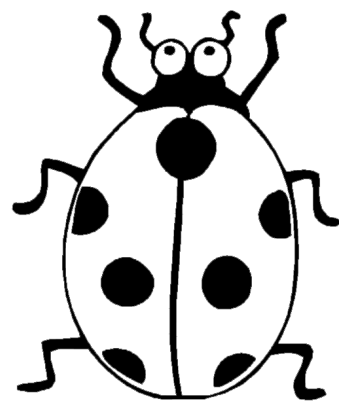
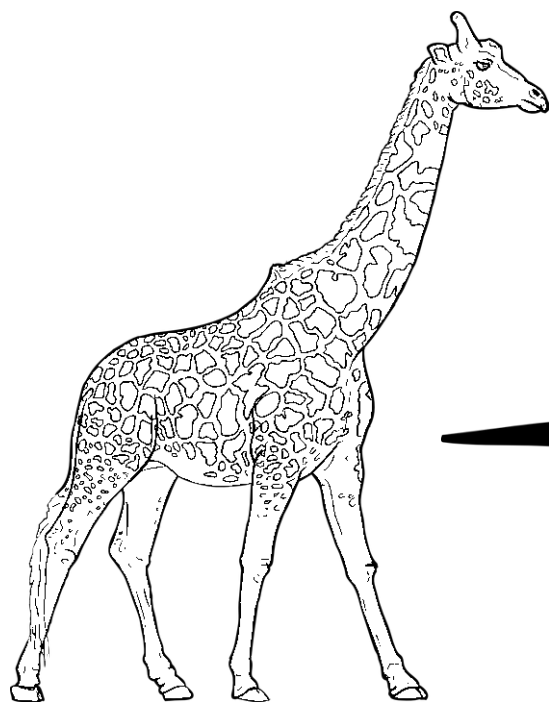
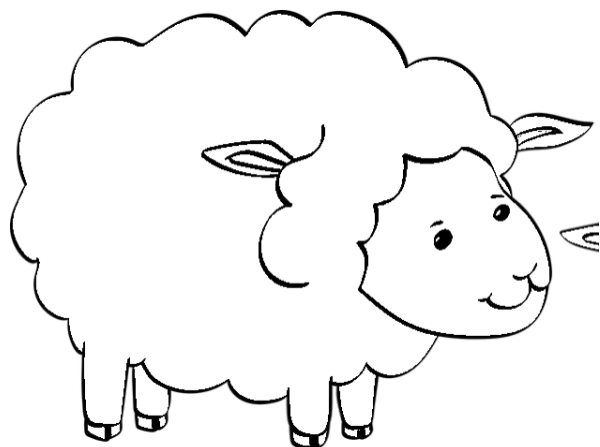
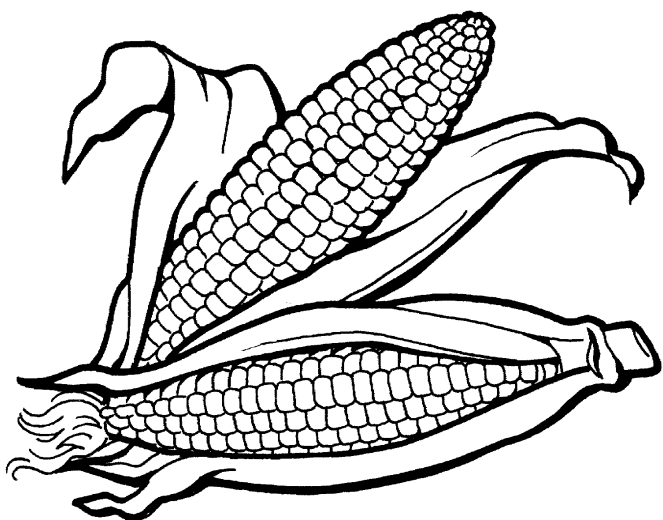

Nn

Fyld bogstaverne ud med
flotte mønstre og farver.

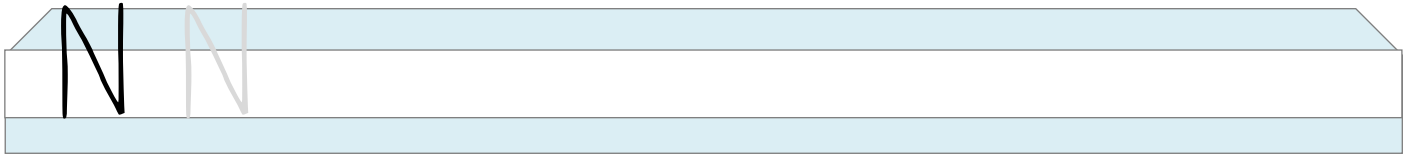
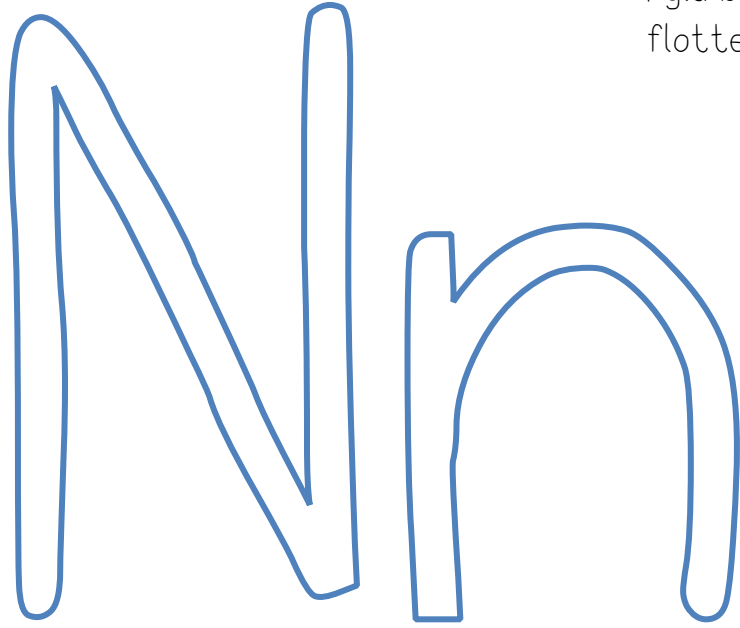

nøgle



nål



nasehorn

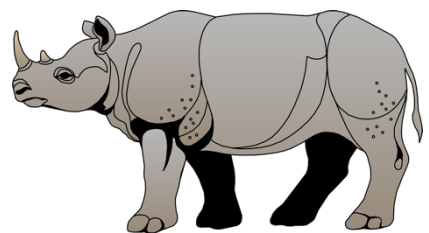

Find N'erne i rækken af bogstaver. Sat ring om dem.

h j n g t n b f d r e s n a n p

S N U K N L Æ P Å N H F N B V F

n m u o m n m u n m n m n u m

N M N W M V W M N M N V M

Hvad starter med N? Skriv eller tegn i kassen.

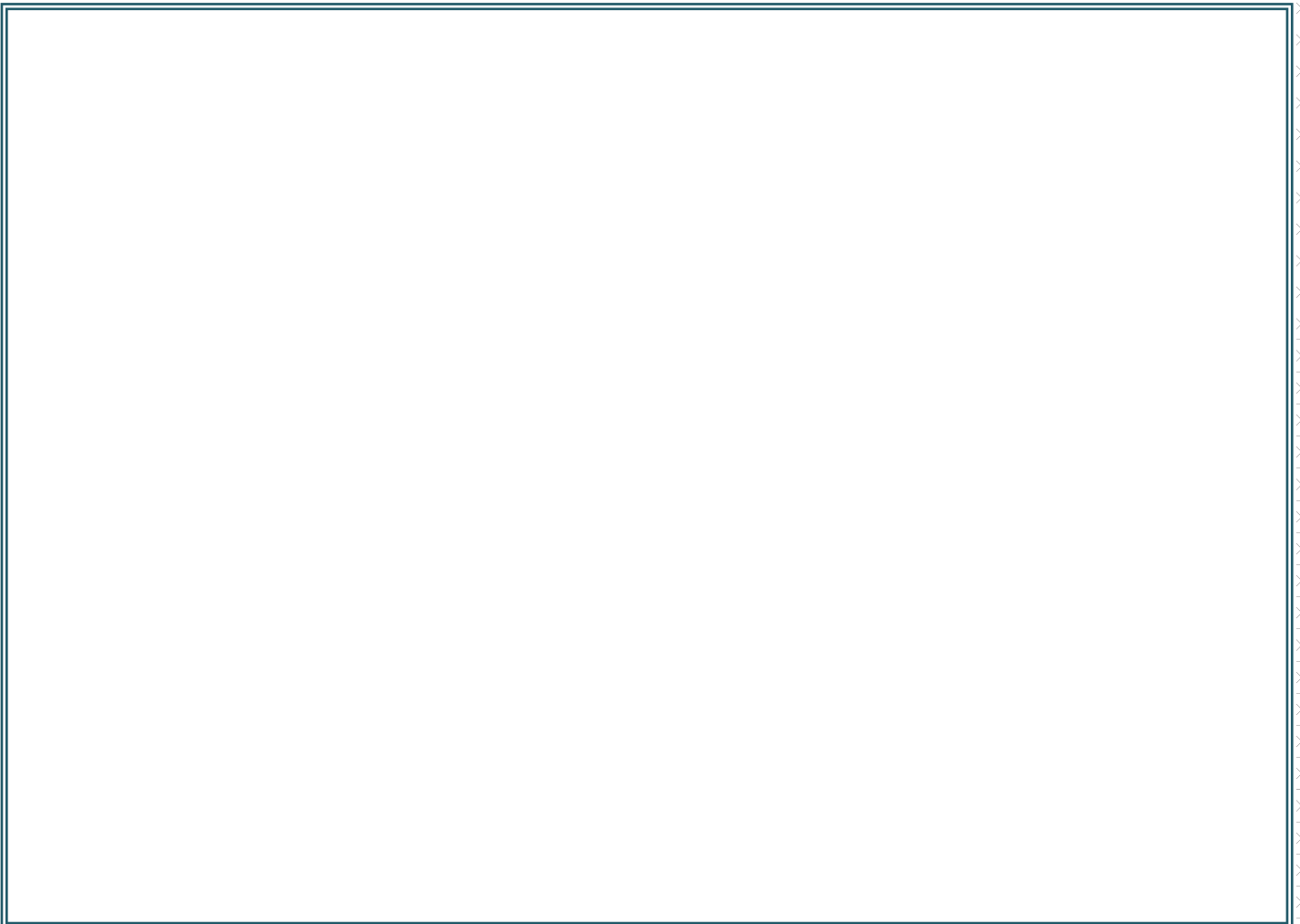

Hvad starter med N? Sæt ring om billedet.

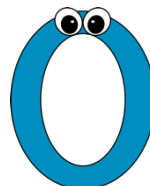
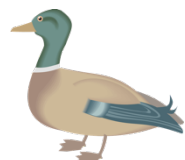
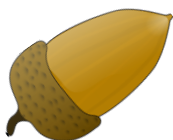

Sæt streg fra billedet til det rigtige ord.



nål



nød



node

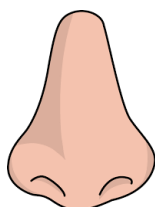

ni



næse

Fyld bogstaverne ud med
flotte mønstre og farver.

O o

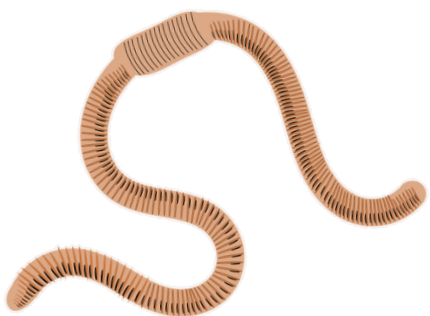
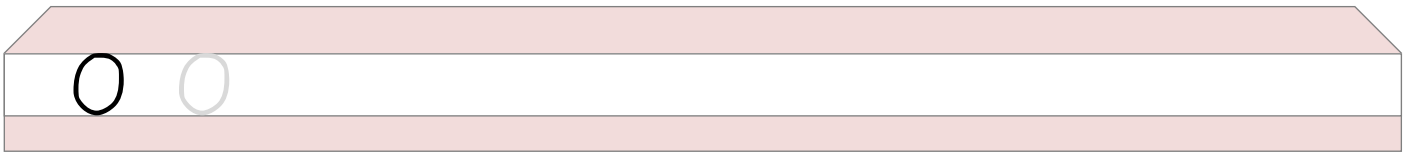
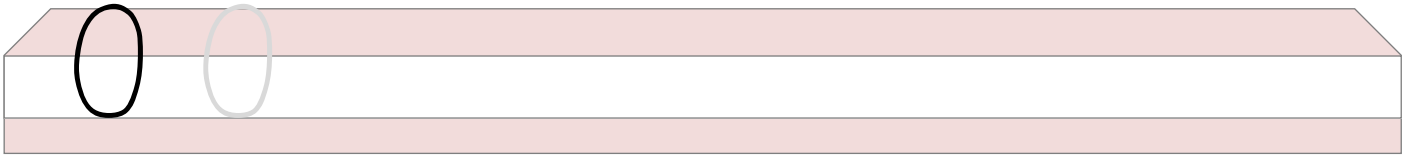
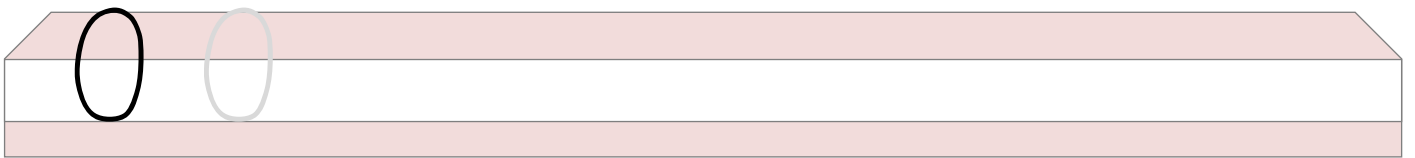
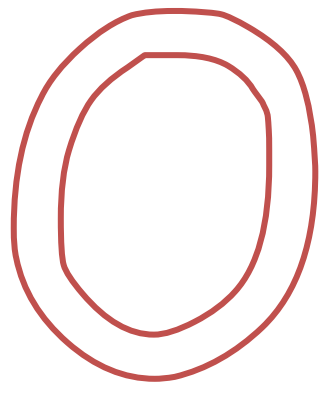
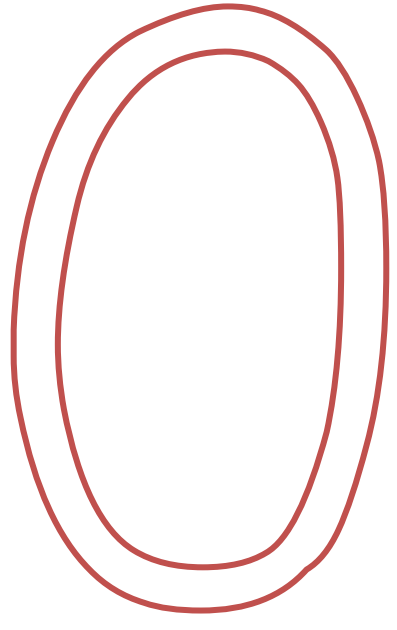

orm

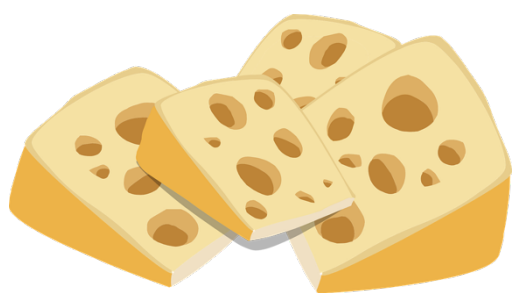

ost

Find O'erne i rækken af bogstaver. Sæt ring om dem.

k l o i g o s t b v o g w p o l o

W S O P L Æ O N M O T B O K

a q o ø a c o c o ø a g o u c o

G O C Q O Ø O C Q O Q C Ø O

Hvad starter med O? Skriv eller tegn i kassen.



Skriv det rigtige ord i kassen og sæt ring om det rigtige billede.

k + o =

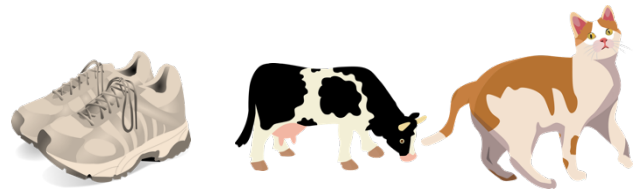

t + o =

2



s + o =



s + k + o =



s + o + l =



b + r + o =



s + o + k =



o + r + m =



Pp



Fyld bogstaverne ud med flotte mønstre og farver.

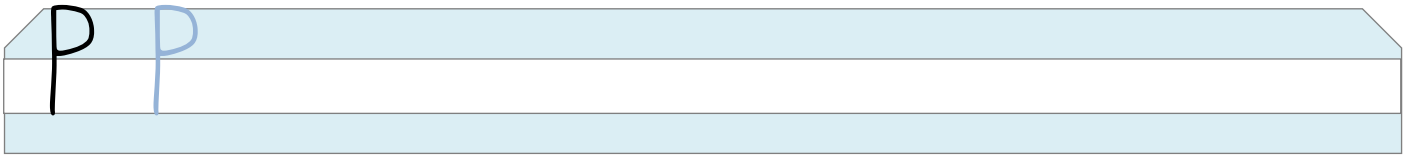

palme



pistol

patroner



pibe



pindsvin

Find P'erne i rækken af bogstaver. Sat ring om dem.

s f p l a m p o k l p t h b p e r

E N P O K J P Ø P Å A S D P Y

o p q j g q p q j g j b p b q p g

R P F B P B F P R P D F Y P D

Hvad starter med P? Skriv eller tegn i kassen.



Hvilket bogstav mangler? Sæt en streg til det rigtige bogstav.



p _ rat



p _ lme



p _ be



p _ stol



p _ nda



p _ l



p _ ge



p _ nde

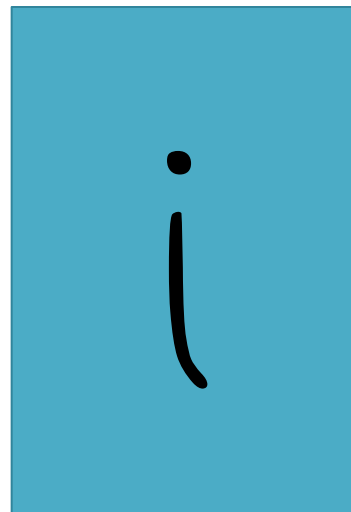

Qq

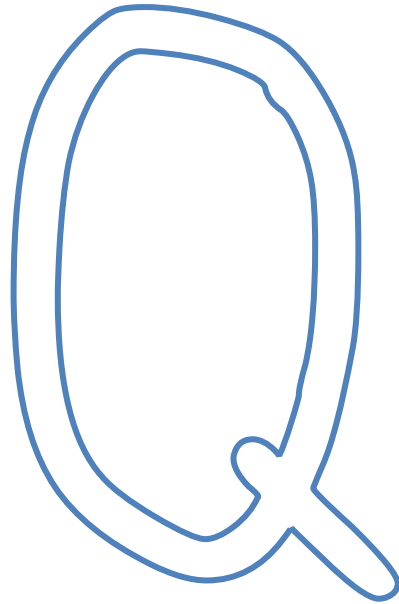

Fyld bogstaverne ud med
flotte mønstre og farver.

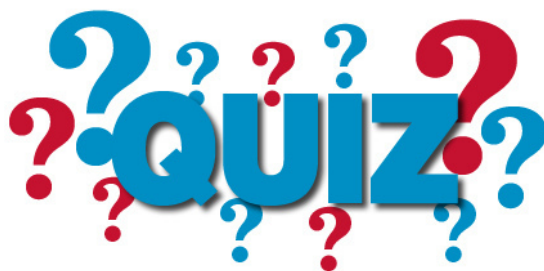
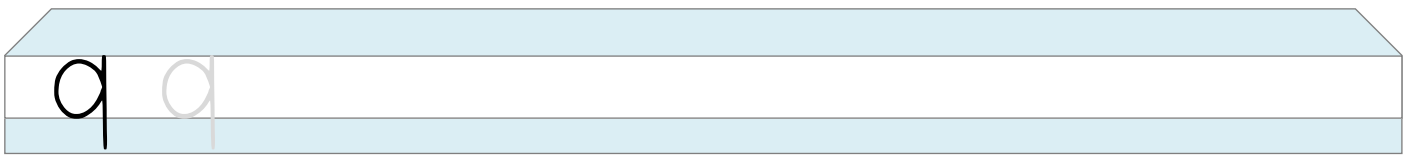
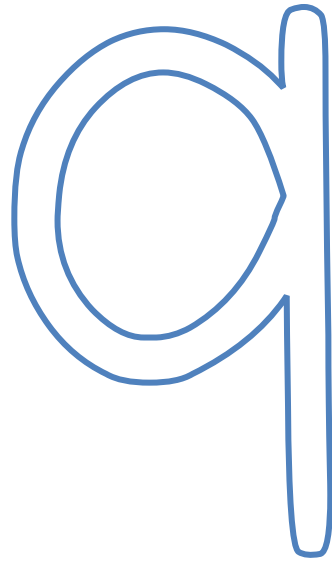

Rr

Rr

Fyld bogstaverne ud med
flotte mønstre og farver.

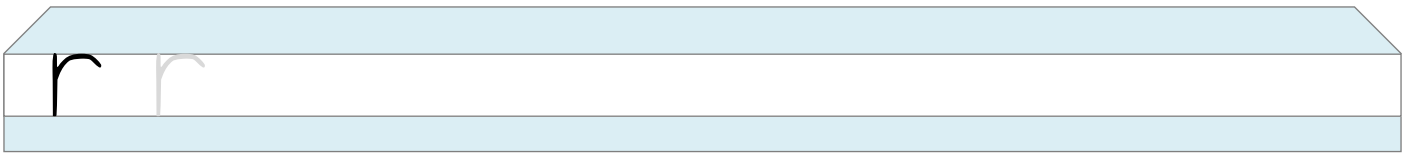
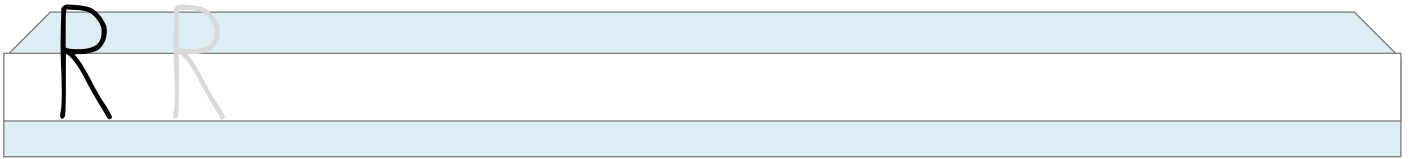
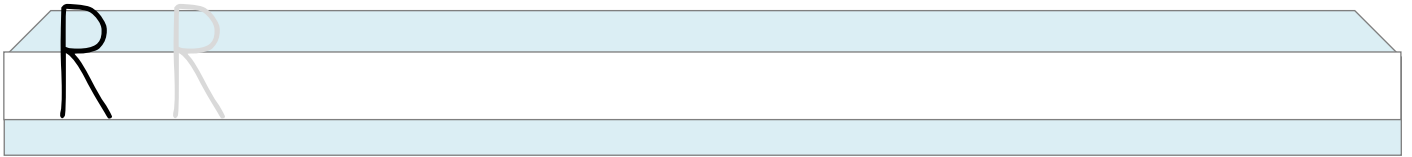

radio



rav

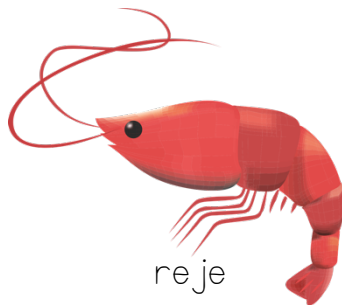

reje

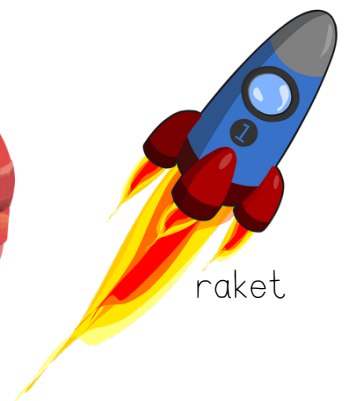

raket

Find R'erne i rækken af bogstaver. Sæt ring om dem.

k l b r t y m s r w e r p a t r

A S R T Y R N I K R L O R P R Å

r v i v r n r l i v n r s r v n m

R P R B P B F P R P D F R R P D

Hvad starter med R? Skriv eller tegn i kassen.



Hvilke dyr starter med R? Find et dyr i hver række.

1:

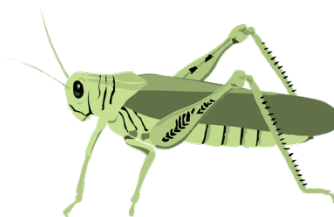
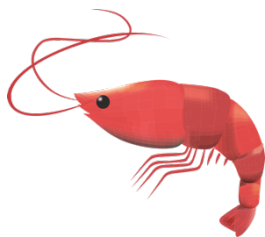

2:

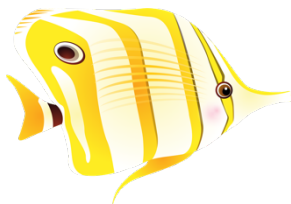

3:

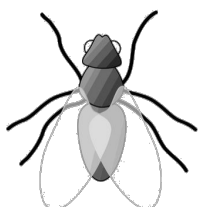

4:

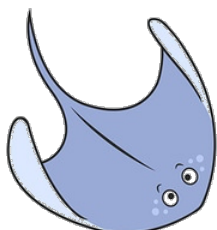

5:

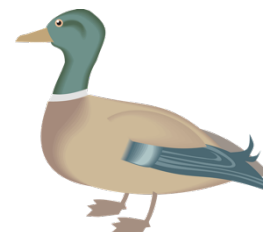
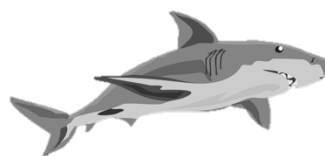

6:

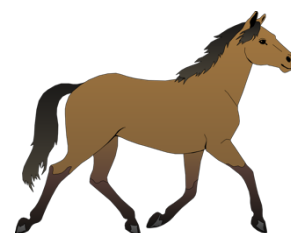
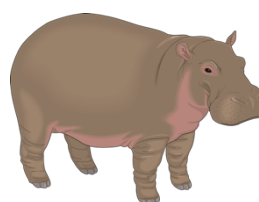

Ss

Fyld bogstaverne ud med
flotte mønstre og farver.

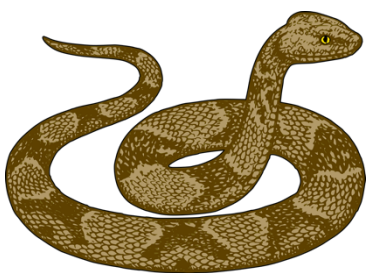
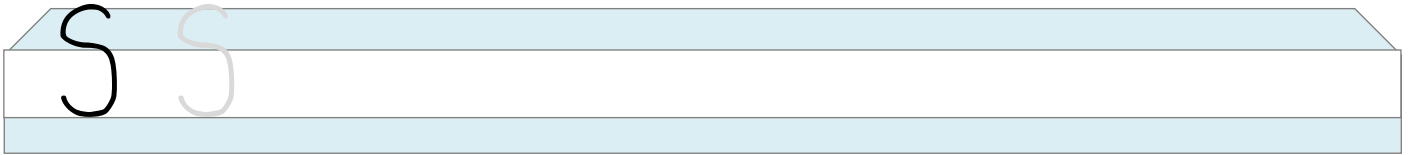
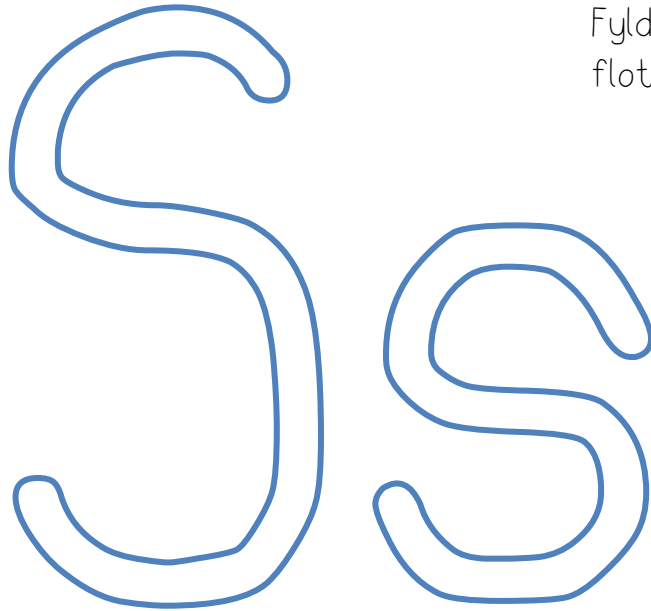

slange



sol



sko

Find S'erne i rækken af bogstaver. Sæt ring om dem.

d r t s f g h s k l o s m n b s p

R F S D T P S Æ K S P Ø M S B

s e o s c s o e r a s e o s c ø r

R S C Z S P S R C Z B S O S Z

Hvad starter med S? Skriv eller tegn i kassen.

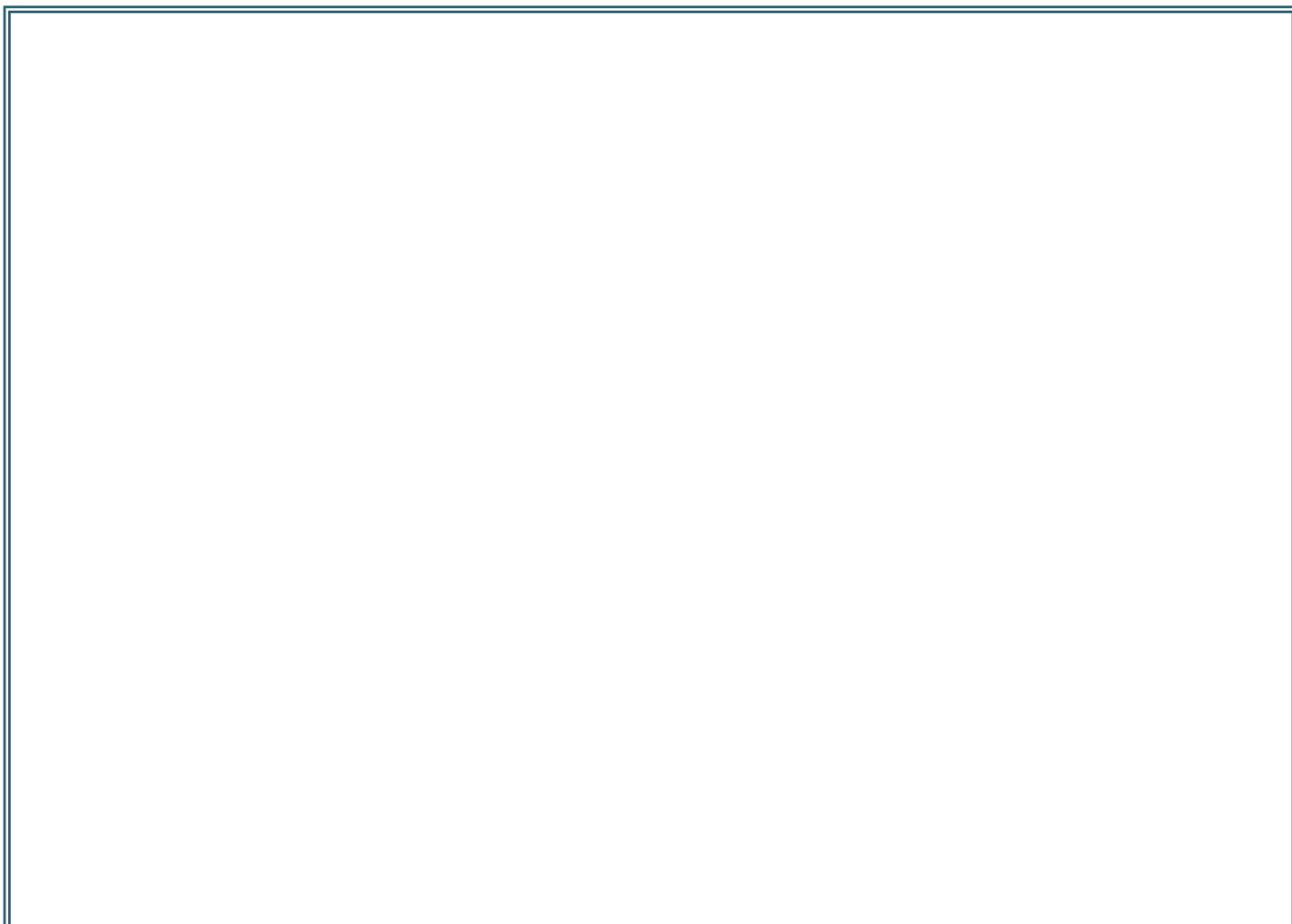

Find vej fra start til slut. Du må kun gå på ord, der starter med S.

| | | | | | |
|---|---|---|---|---|---|
| Start → |  |  |  |  |  |
|  |  |  |  |  |  |
|  |  |  |  |  |  |
|  |  |  |  |  |  |
|  |  |  |  |  |  |
|  |  |  |  |  | Slut |

Hvor mange store og små S'er kan du finde? Skriv det i kassen.

Simon spiser is og slik med Sasja. "Se min is" siger Sasja, den er smeltet.

S S

Tt

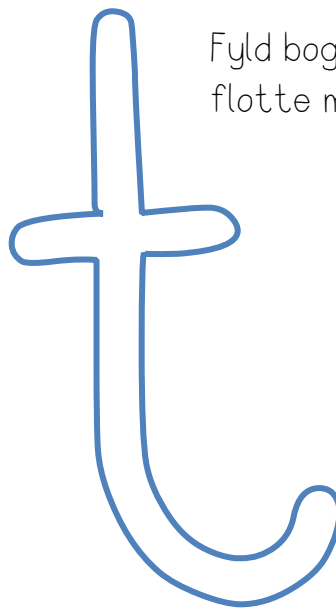
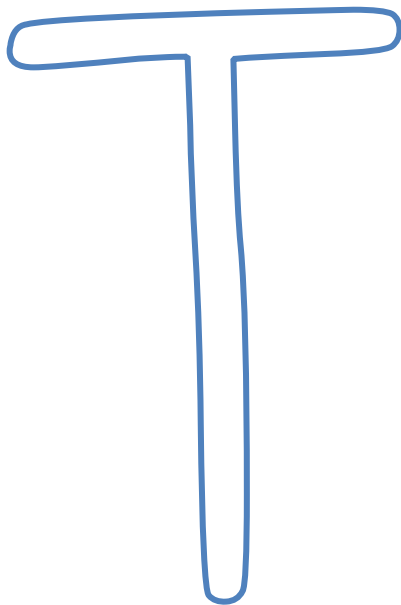

Fyld bogstaverne ud med
flotte mønstre og farver.

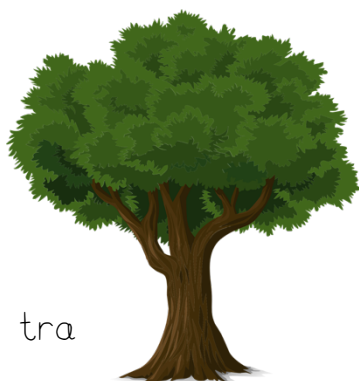

tra



tiger



traktor

Find T'erne i rækken af bogstaver. Sat ring om dem.

p t h j t g n s t u k v t u m n

A S T H M T Y N T O P L T K T

l i t f k l t f l t i k l t f l f t k

T L I F E T P T I T F E F T I L

Hvad starter med T? Skriv eller tegn i kassen.

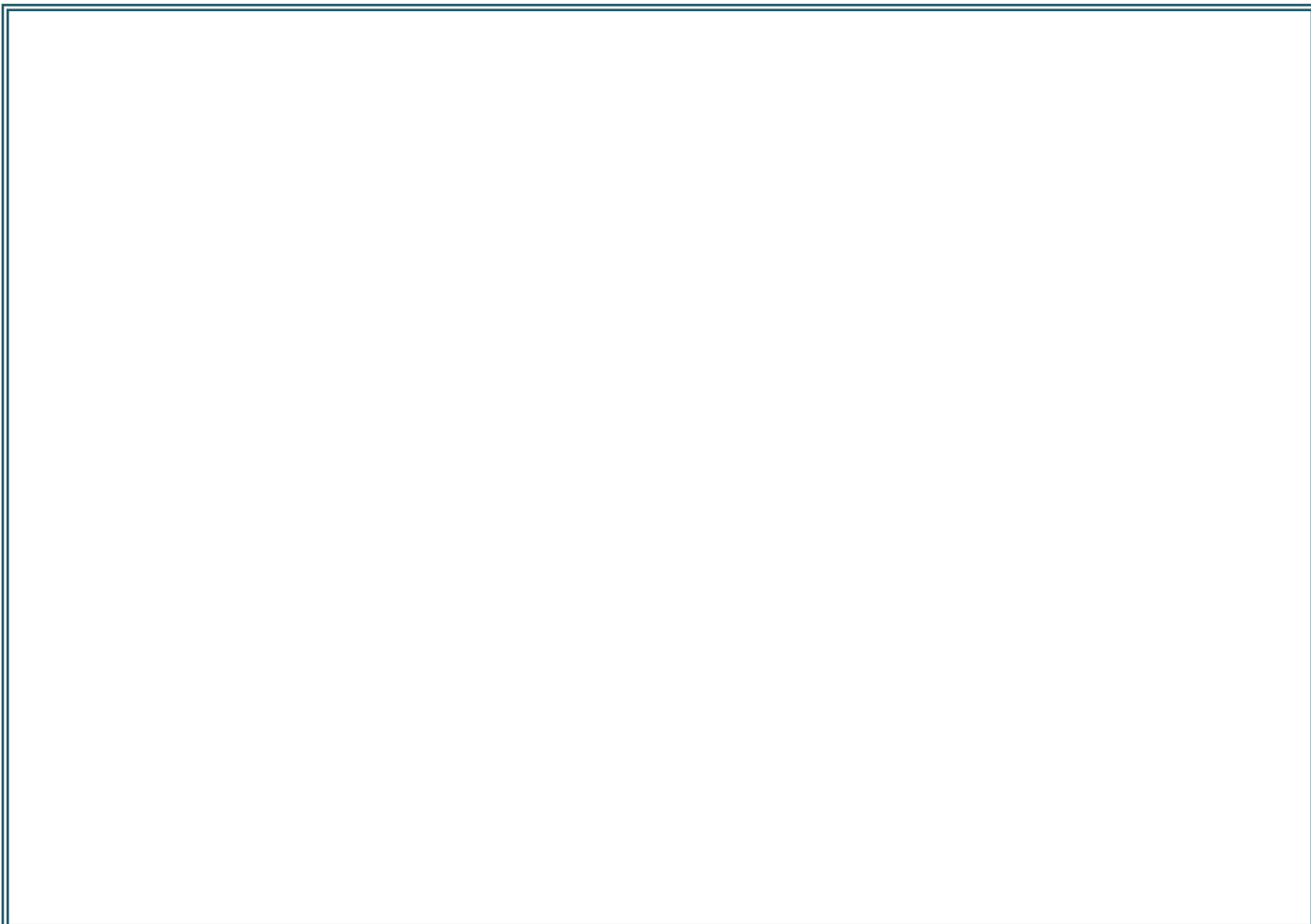

Farv de billeder, der starter med T.

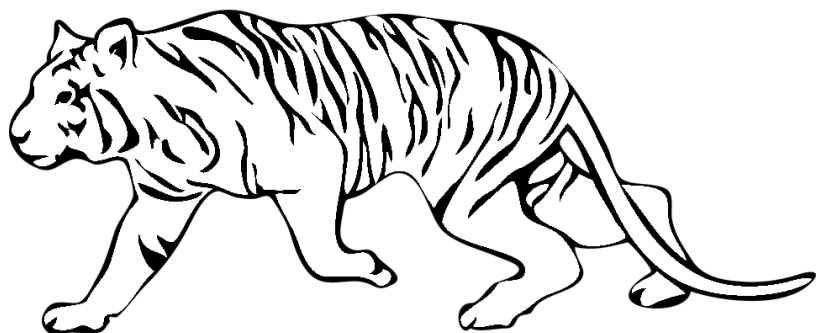
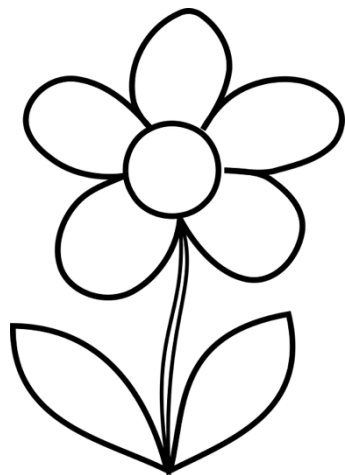
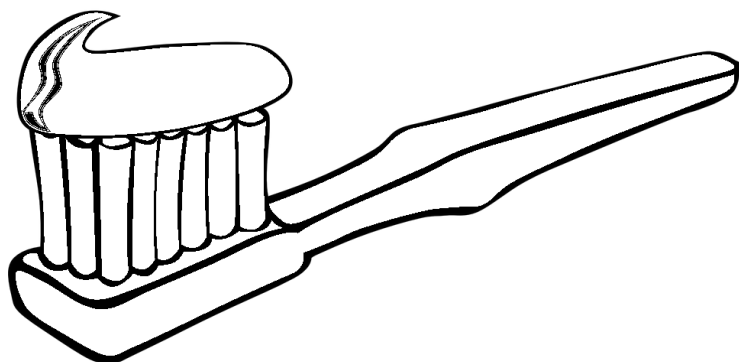
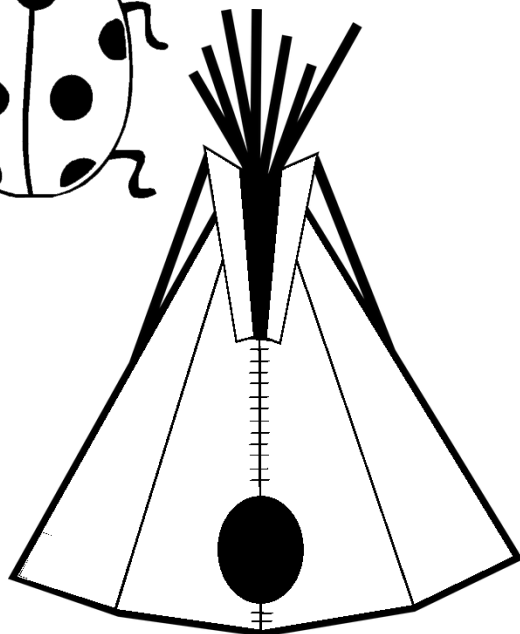
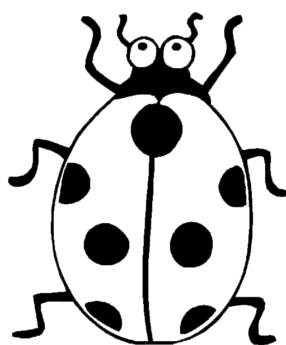
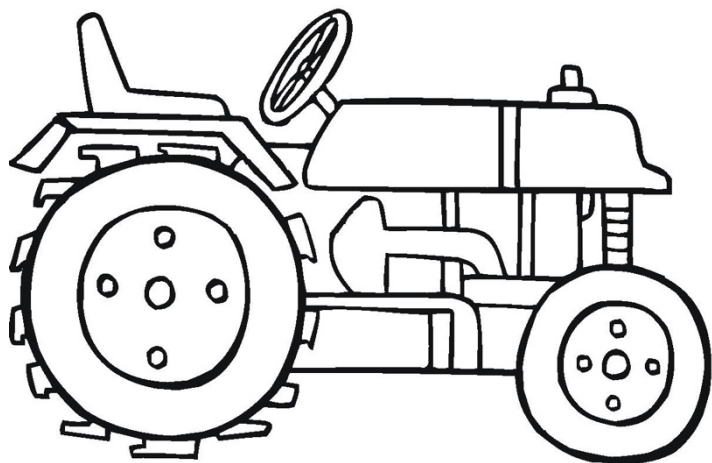

Fyld bogstaverne ud med
flotte mønstre og farver.

Uu

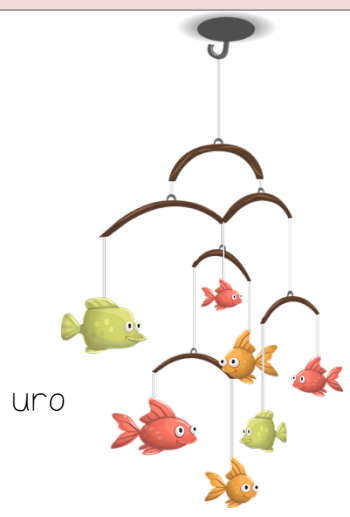
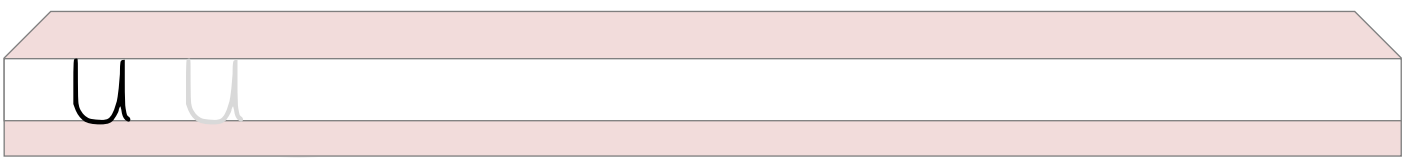
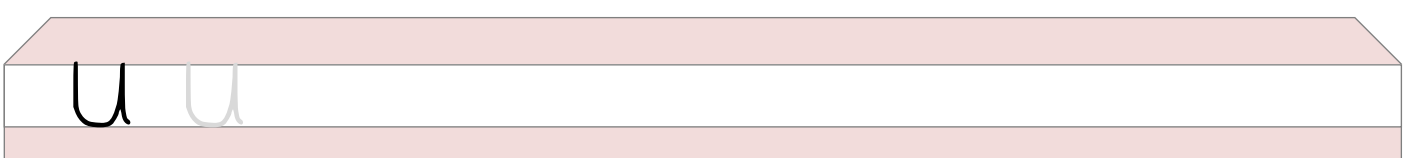
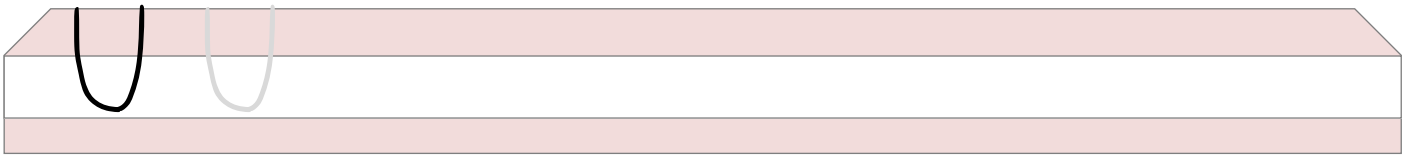
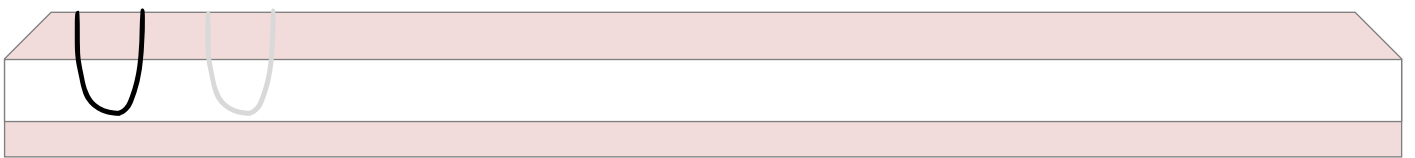
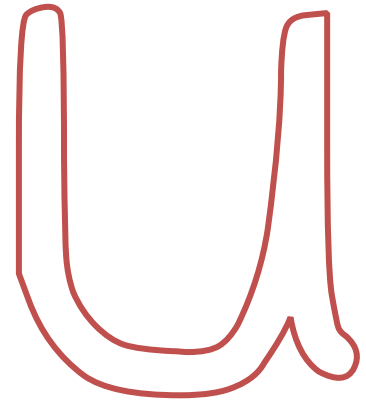
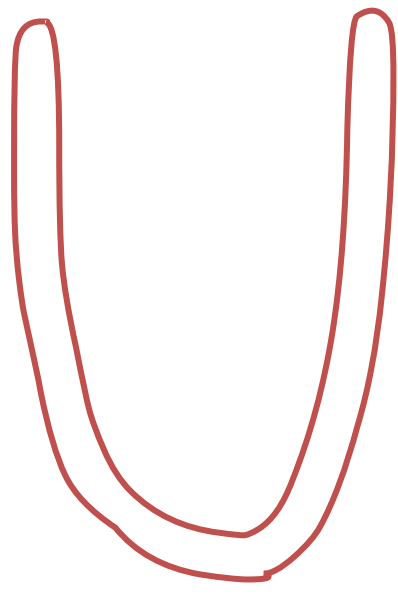

Find U'erne i rækken af bogstaver. Sat ring om dem.

u k j r t u g w s u p ø u å l k

A R U K M U H N P U C W U L

v u a n u n a v u a e m u n a v

U Y V U O V Q U V Y U V V U

Hvad starter med U? Skriv eller tegn i kassen.



Sæt streg fra billedet til det rigtige ord.



ufo



uro



ulv

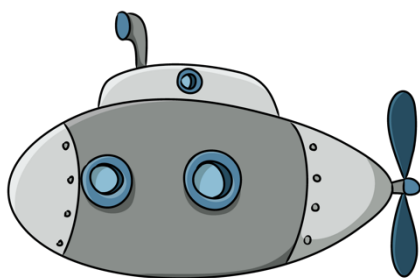

ubåd



ur

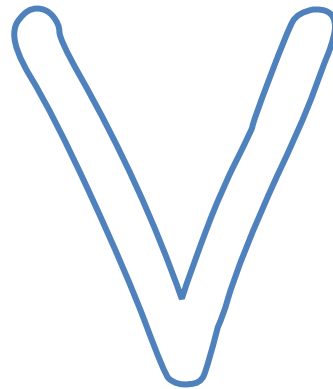

Fyld bogstaverne ud med
flotte mønstre og farver.



violin



vin

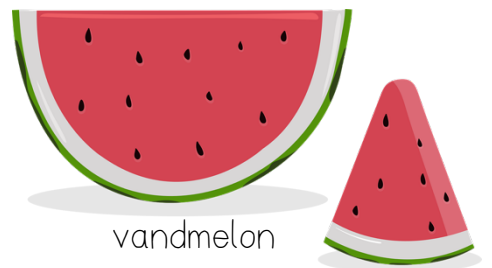

vandmelon

Find V'erne i rækken af bogstaver. Sæt ring om dem.

h v g r t v k s v a k o v f g v

A S V H J V Æ L Å V W E R V B

u v n x v u y v y n u v y n v y

Y V N M V Y U V N U V Y M V

Hvad starter med V? Skriv eller tegn i kassen.

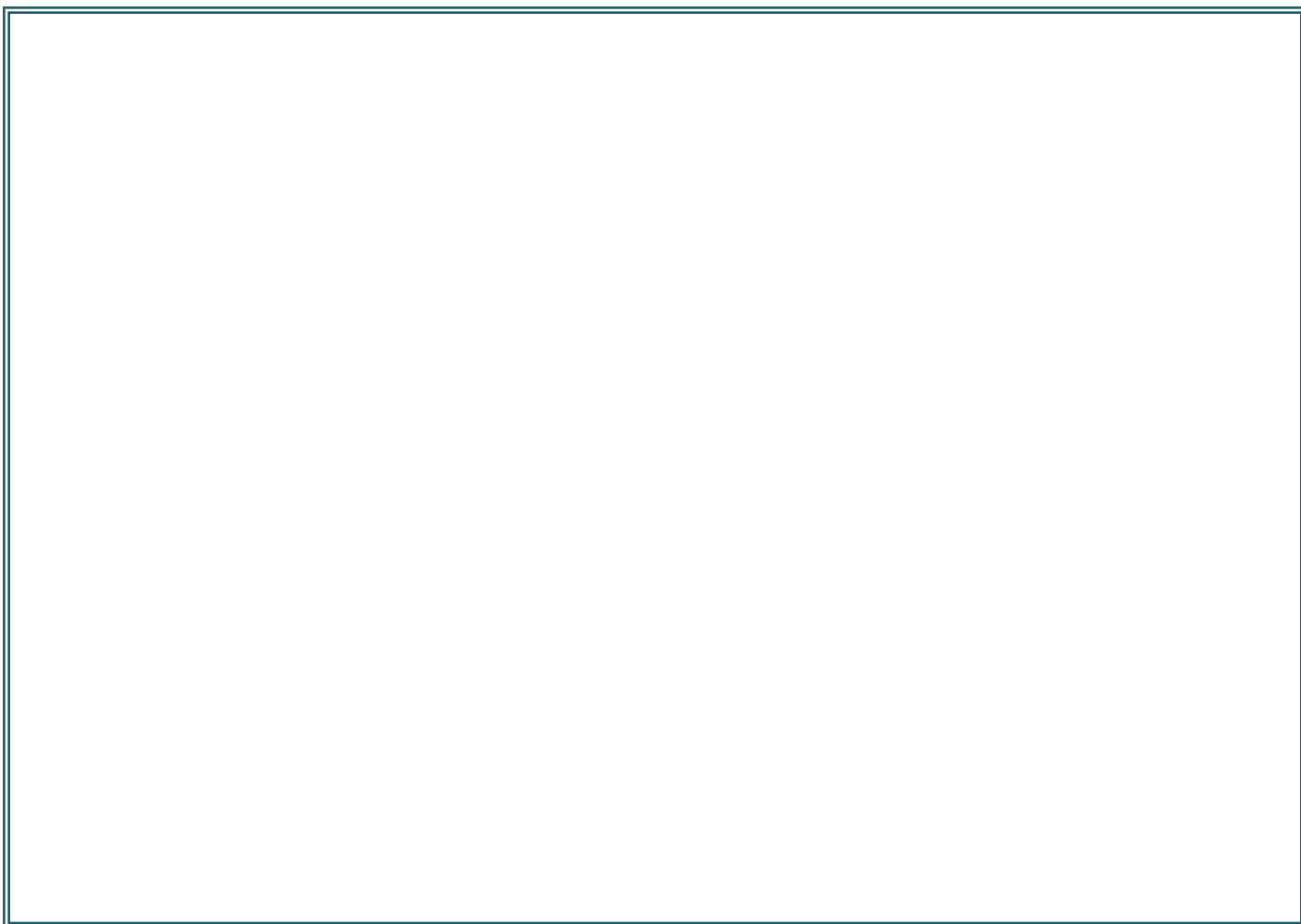

Hvad viser billedet? Skriv ordet i kasserne.



| | | |
|--|--|--|
| | | |
|--|--|--|



| | | |
|--|--|--|
| | | |
|--|--|--|



| | | |
|--|--|--|
| | | |
|--|--|--|



| | | |
|--|--|--|
| | | |
|--|--|--|



| | | |
|--|--|--|
| | | |
|--|--|--|



| | | | |
|--|--|--|--|
| | | | |
|--|--|--|--|



| | | | |
|--|--|--|--|
| | | | |
|--|--|--|--|



| | | | |
|--|--|--|--|
| | | | |
|--|--|--|--|

Fyld bogstaverne ud med
flotte mønstre og farver.

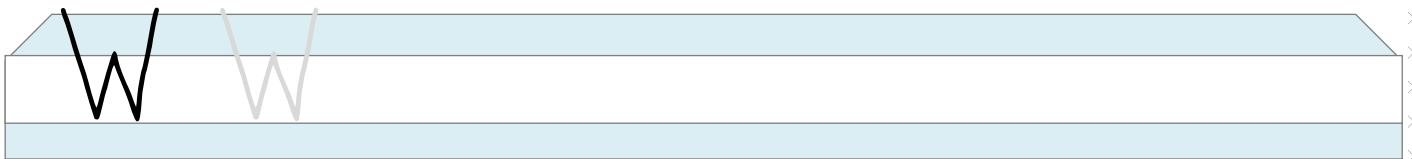

WC

X x

Fyld bogstaverne ud med
flotte mønstre og farver.

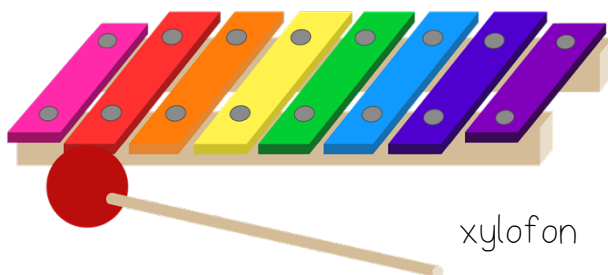
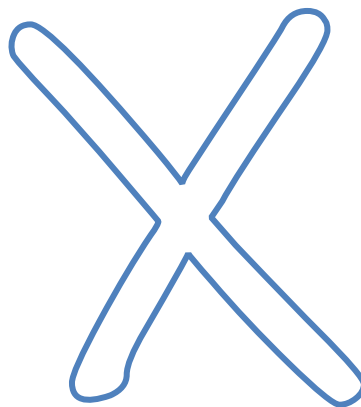
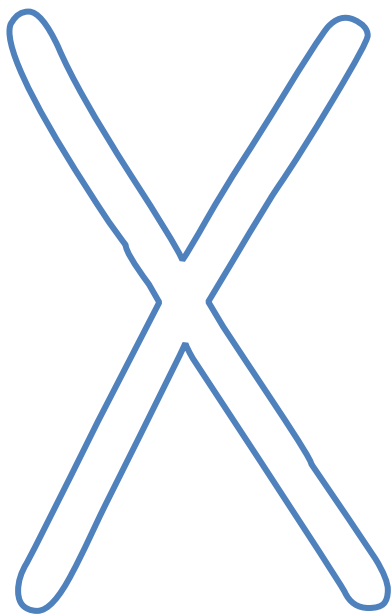

xylofon

Y y

Fyld bogstaverne ud med
flotte mønstre og farver.

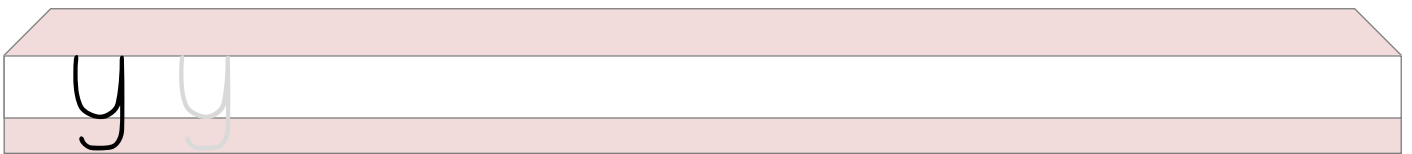
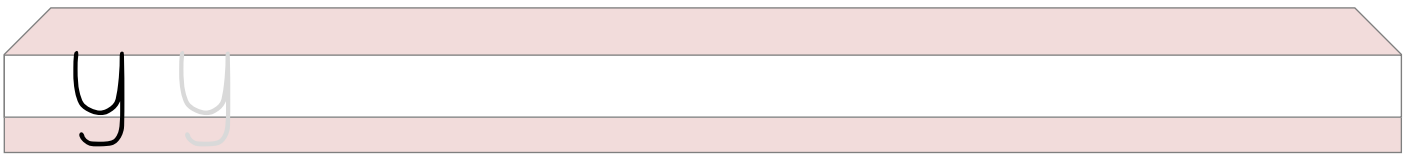
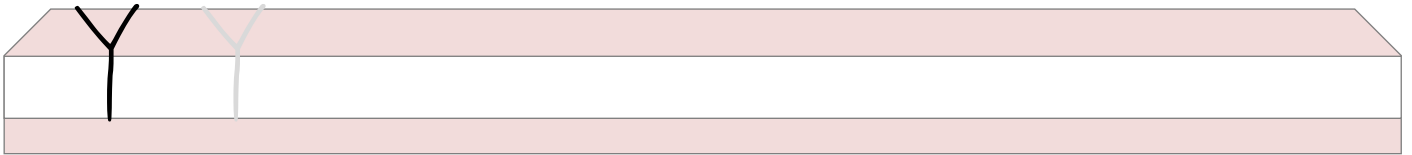
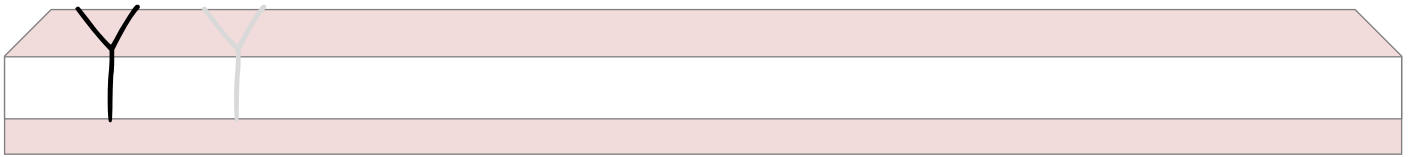
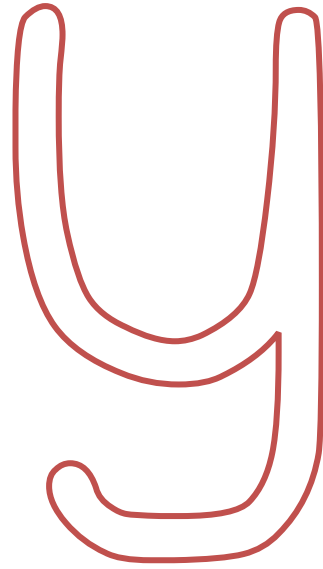
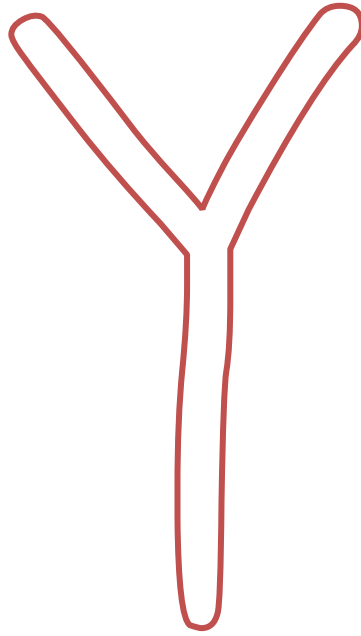

Find Y'erne i kassen med bogstaver. Sat ring om dem.

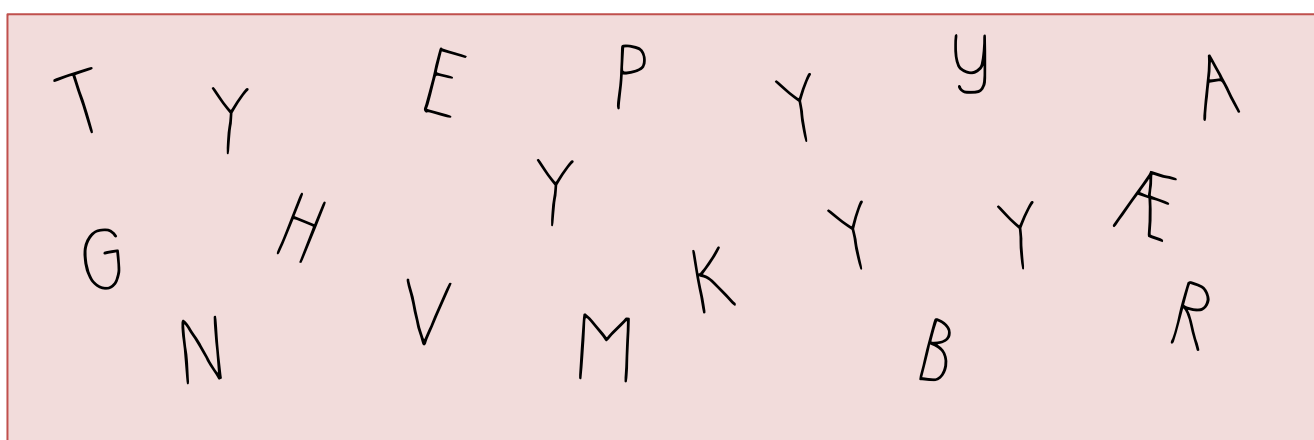
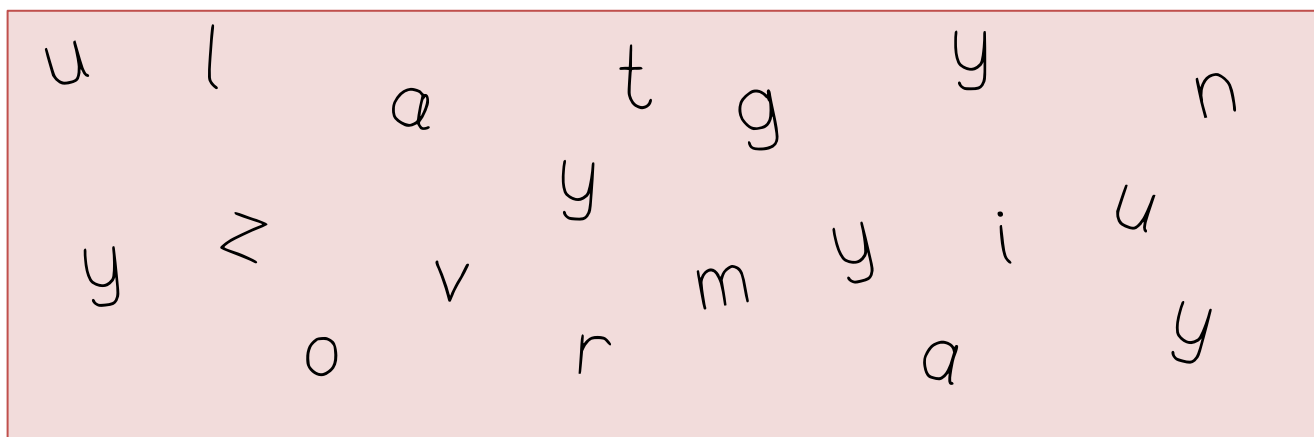

Find Y'erne i kassen med bogstaver. Sat ring om dem.

t + y + v =



s + y + v =



l + y + n =

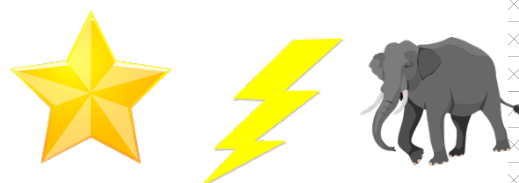

Zz

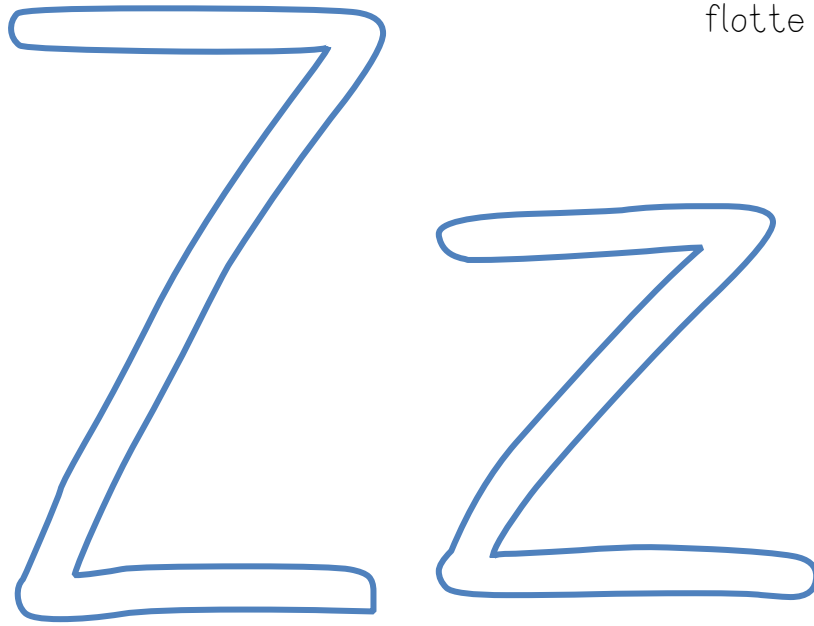

Fyld bogstaverne ud med
flotte mønstre og farver.

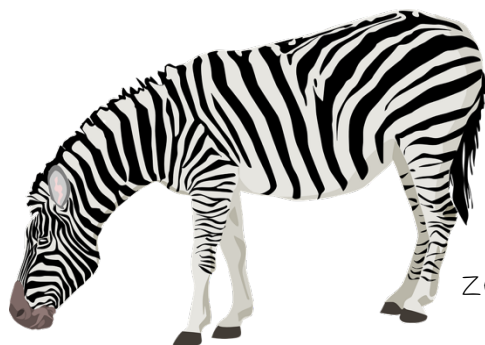

zebra

Aa

Fyld bogstaverne ud med
flotte mønstre og farver.

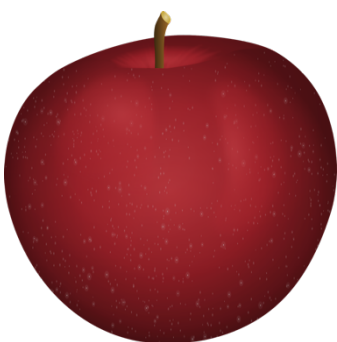
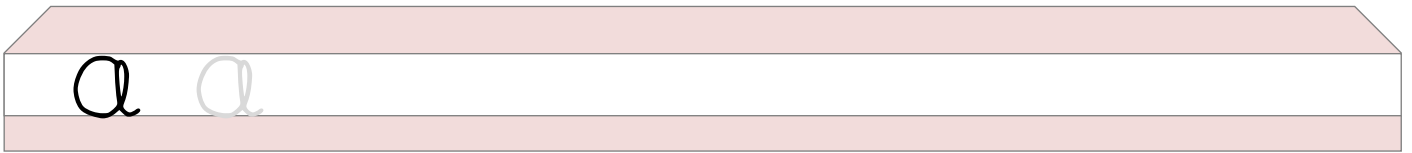
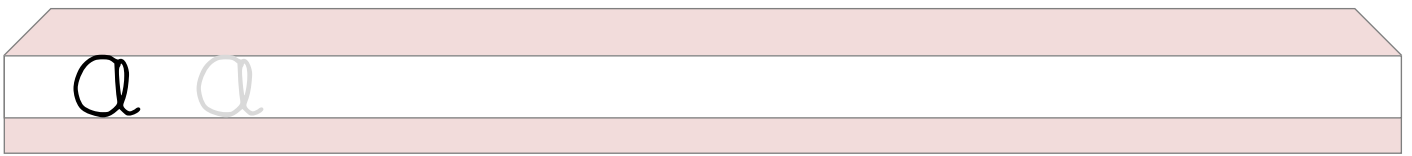
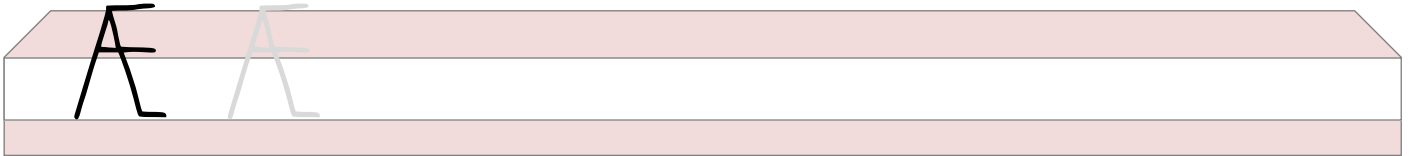
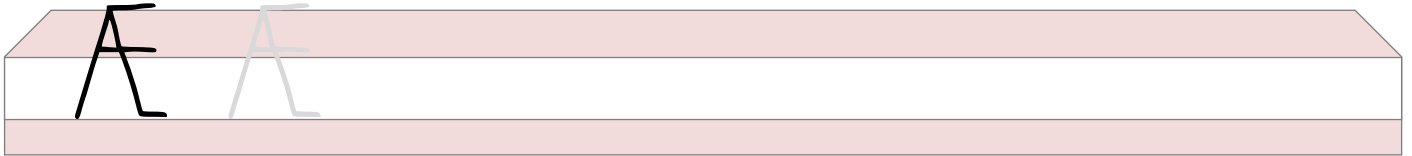
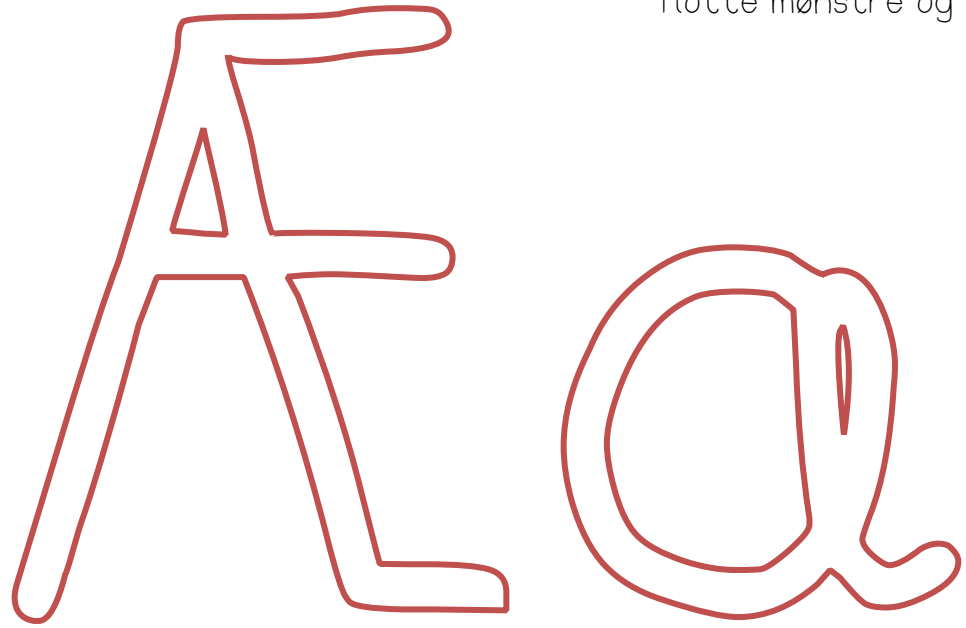

able

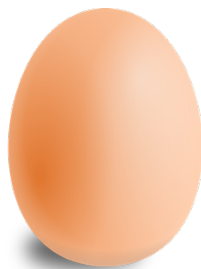

ag



asel



art

Find Æ'erne i kassen med bogstaver. Sat ring om dem.

a a i a a i a b
r t y h a
v a g a p u

A Æ A Æ L Æ A
E y E M E
B Æ K Å Ø E O Æ

Hvilken vokal passer ind i ordet? Skriv den på linjen.



b _ r

a
ø
æ



s _ l

a
ø
æ



f r _

a
ø
æ



b _ d

a
ø
æ



_ b e

a
ø
æ

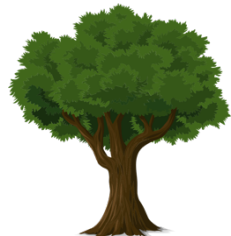

t r _

a
ø
æ

Fyld bogstaverne ud med
flotte mønstre og farver.

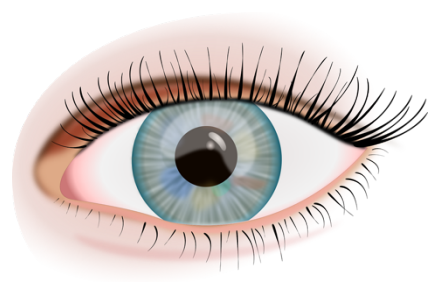
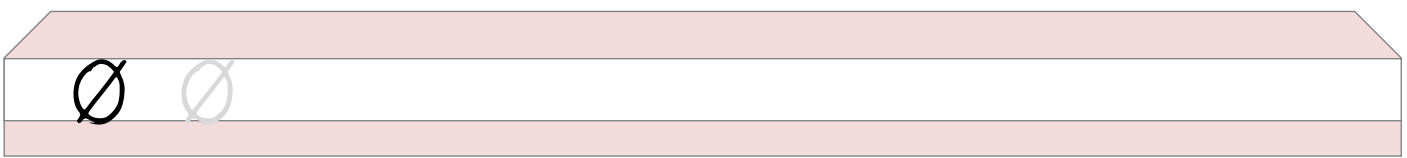
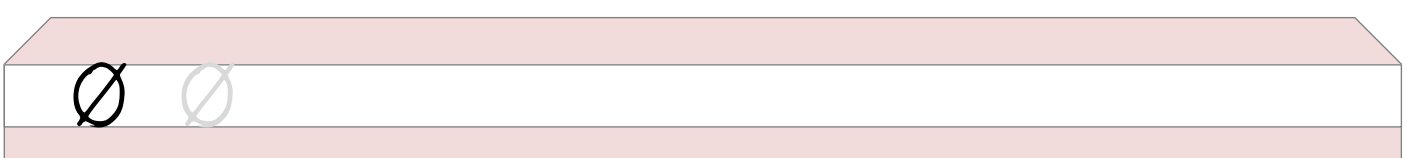
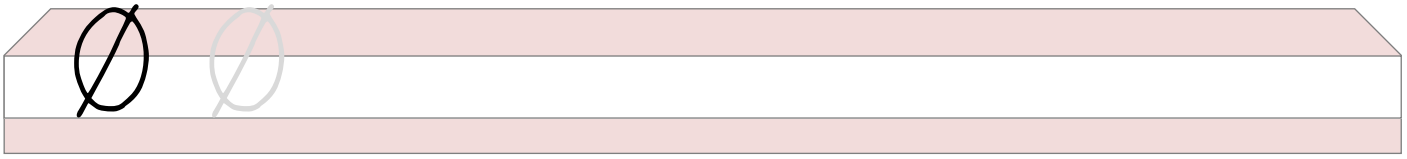
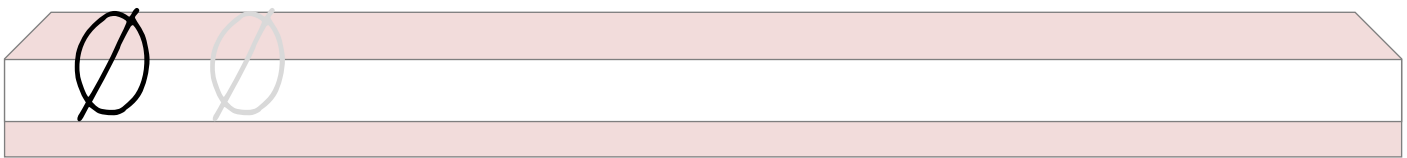
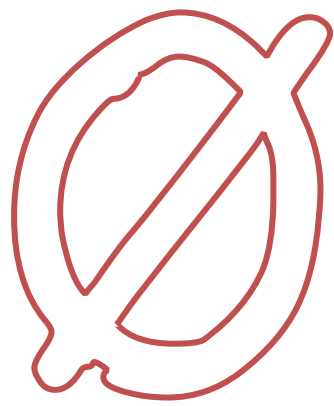

øje



økse



øre

Find Ø'erne i rækken af bogstaver. Sæt ring om dem.

k ø å m n r ø t h b ø q r s ø m

A S Ø P M Ø B L H Ø R T W Q

o a ø c o ø å ø o c o ø d o å ø

O Ø Q O C O Ø Q Ø O Å Ø Q Q

Hvad starter med Ø? Skriv eller tegn i kassen.

Farvelag de tegninger, der starter med Ø.

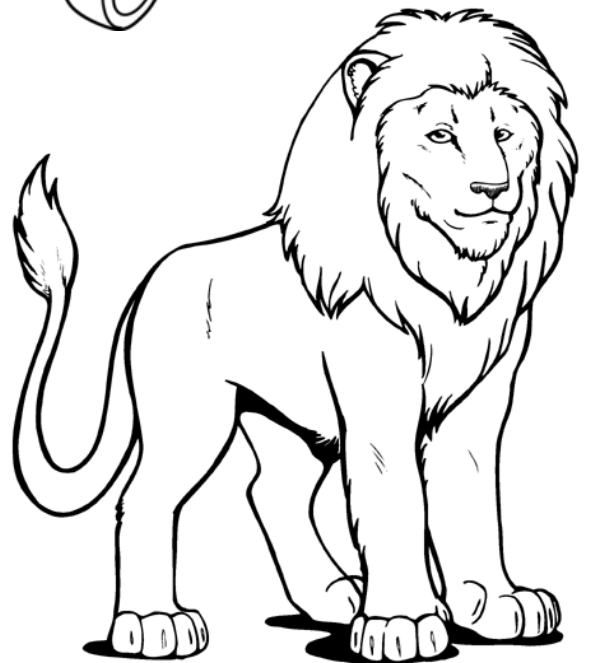
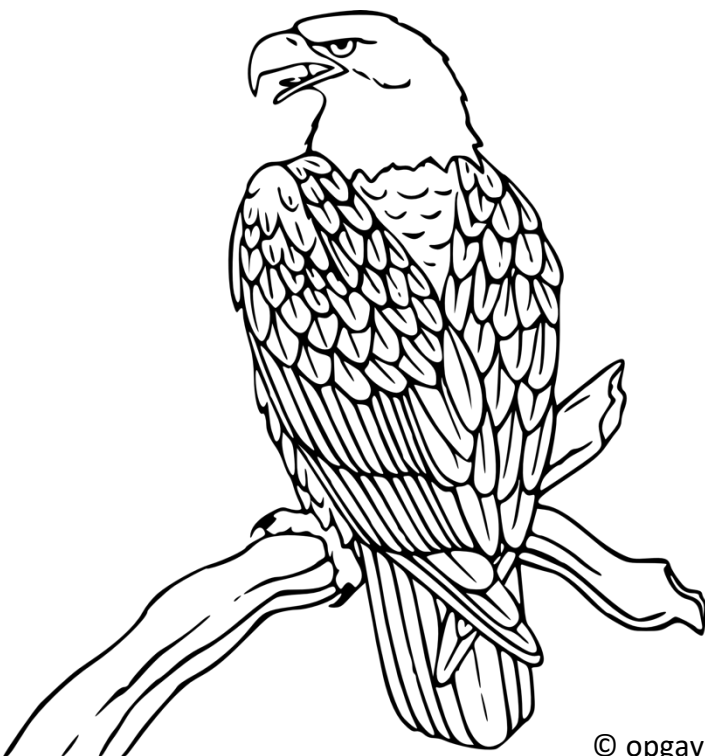
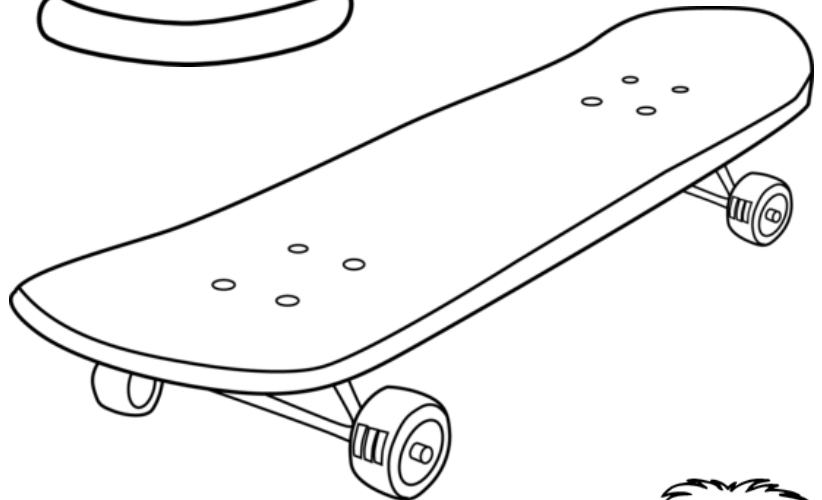
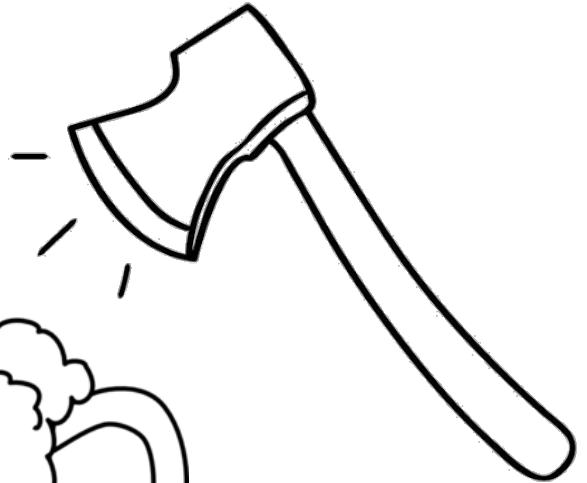
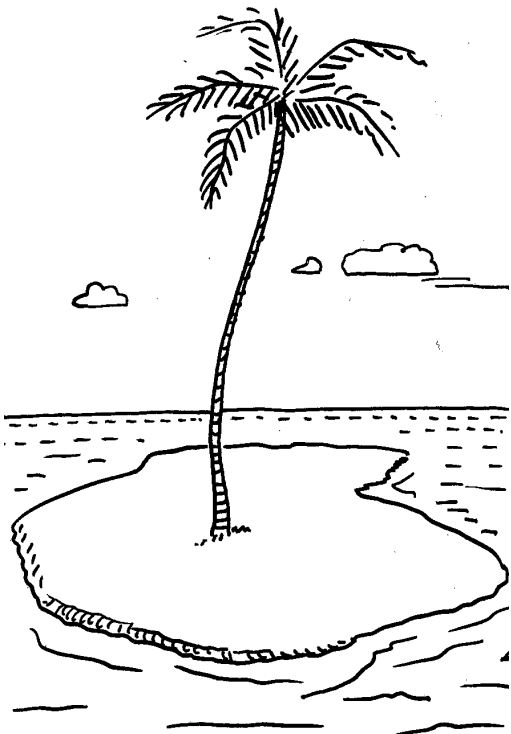

Å å

Fyld bogstaverne ud med
flotte mønstre og farver.

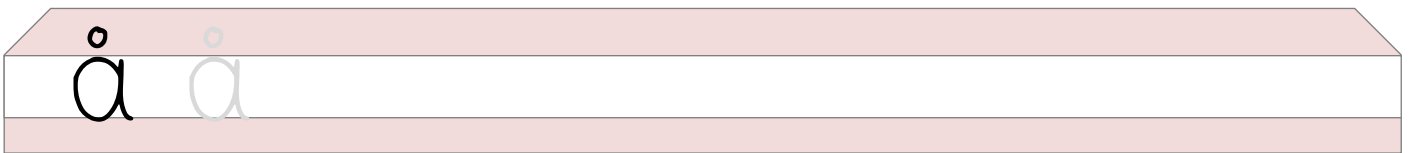
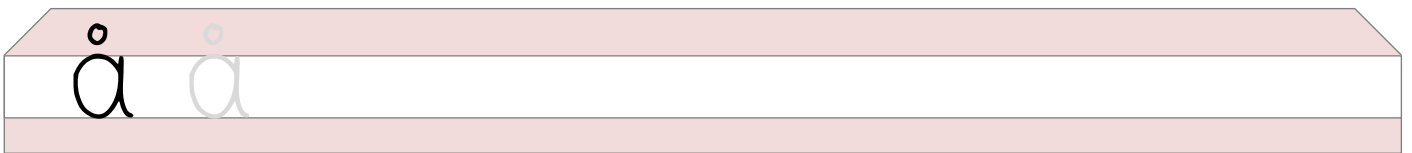
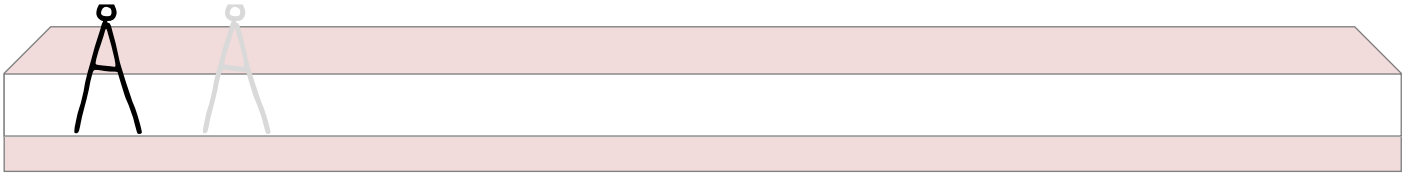
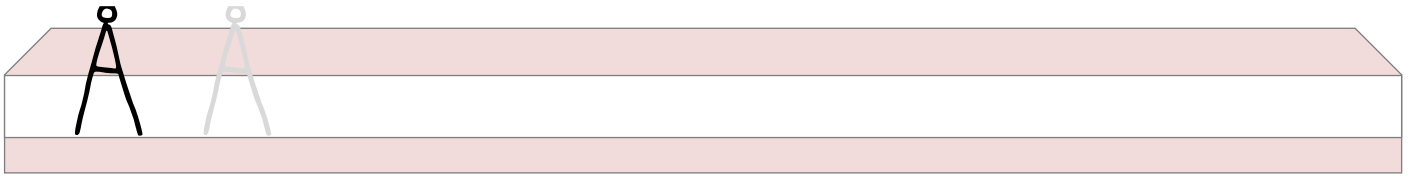
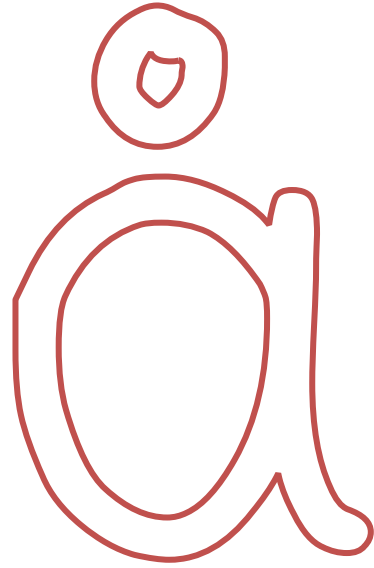
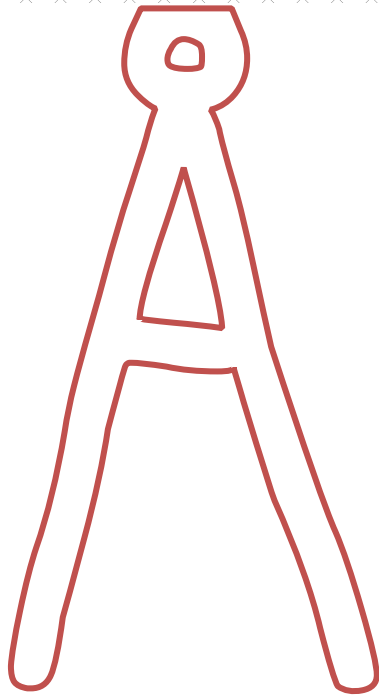

å

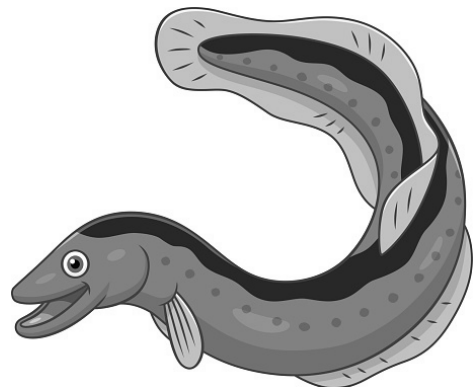

ål

Find Å'erne i kassen med bogstaver. Sat ring om dem.

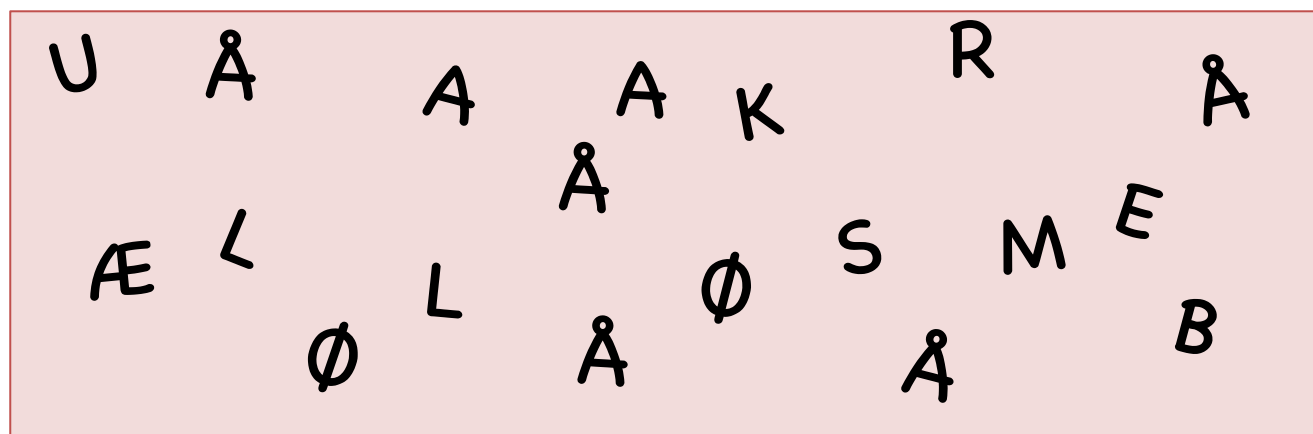
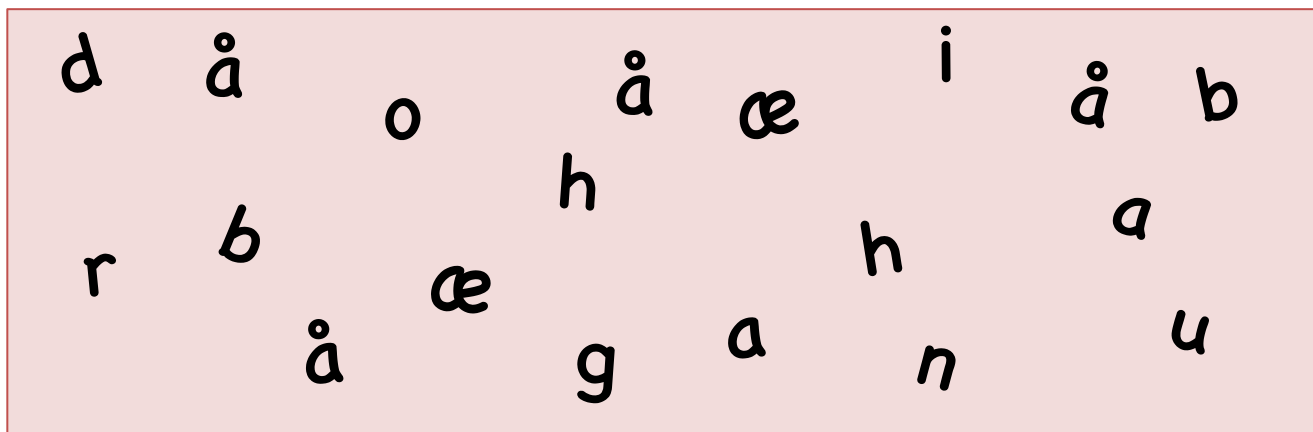

Hvad rimer på bål? Sat ring.



bål

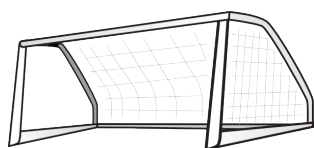

mål



båd



nål



bil



kål



sol