

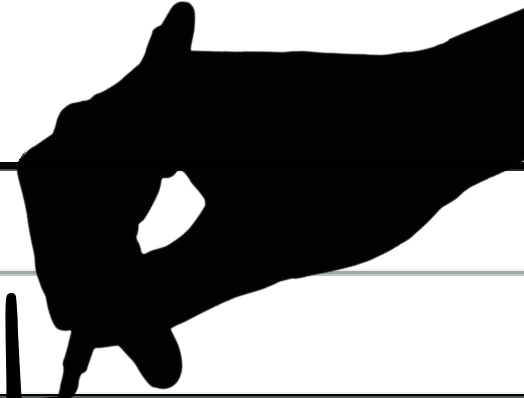

skriv

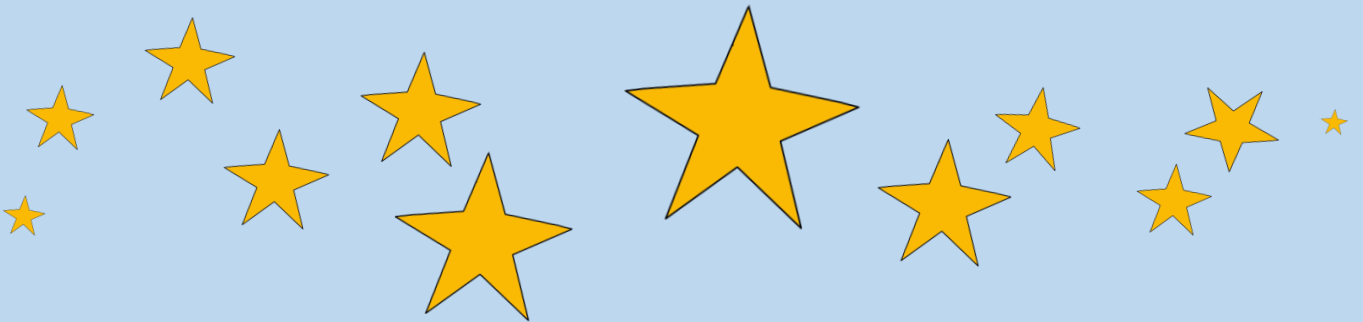

pant



Navn:

Klasse:

© opgaveskyen.dk





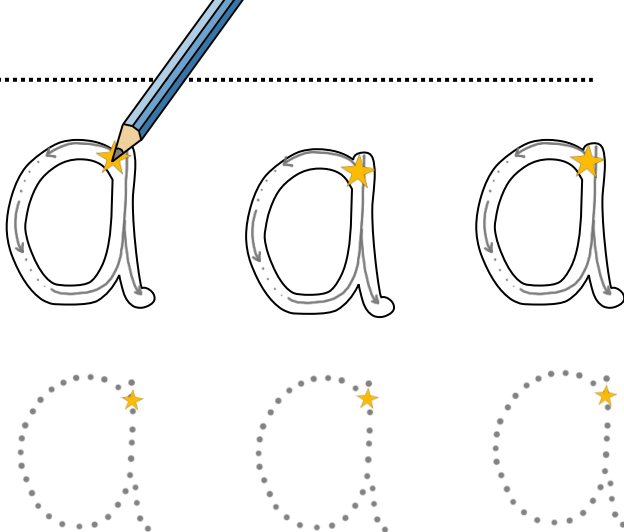
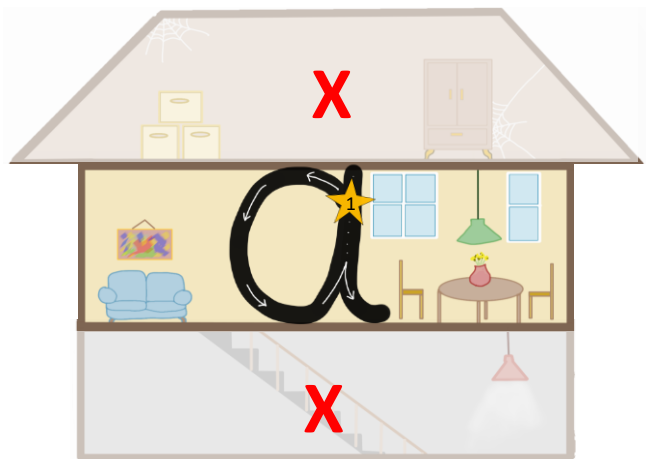

Skriv oven i bogstaverne her. Start ved stjernen.

Nu skal du skrive de flotteste a'er, du kan.

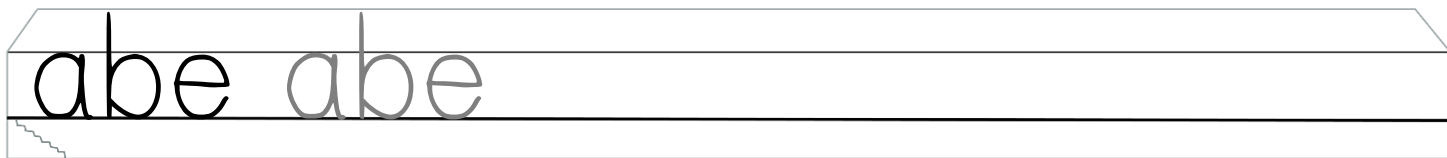
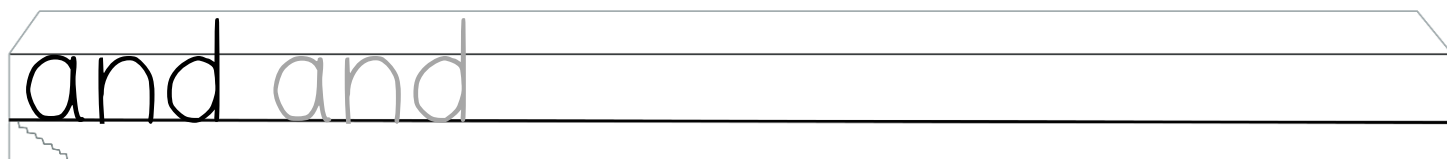
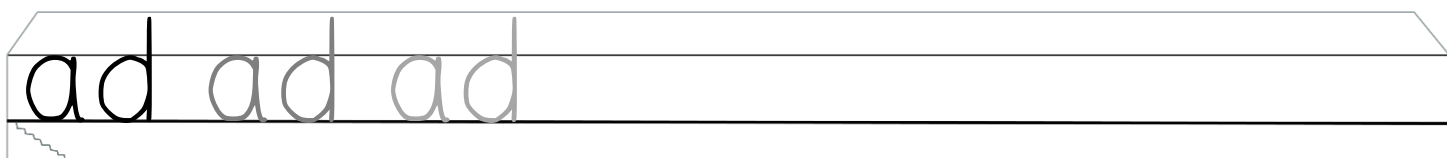
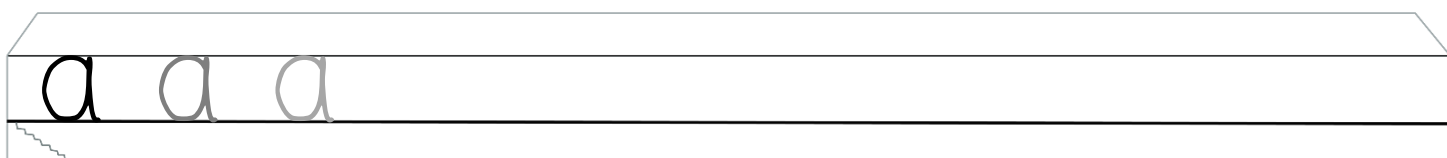

... og så det STORE



abe

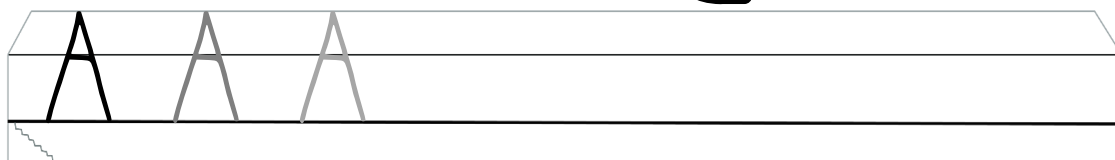
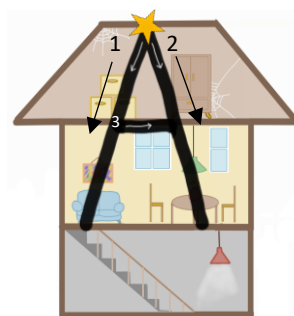

Du fortjener en stjerne, når din lærer har godkendt. Farv stjerne A i stjernesamlingen.



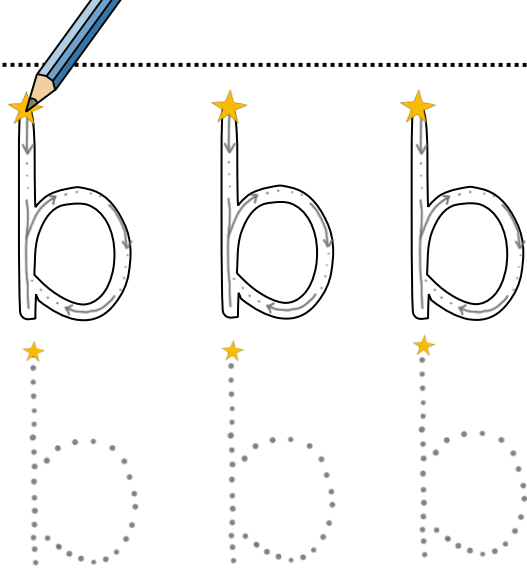

Skriv oven i bogstaverne her. Start ved stjernen.

Nu skal du skrive de flotteste b'er, du kan.

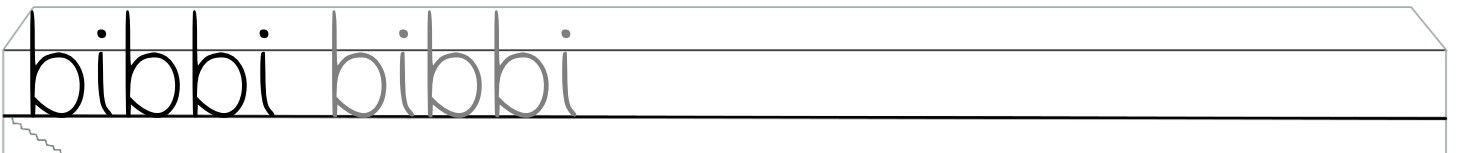
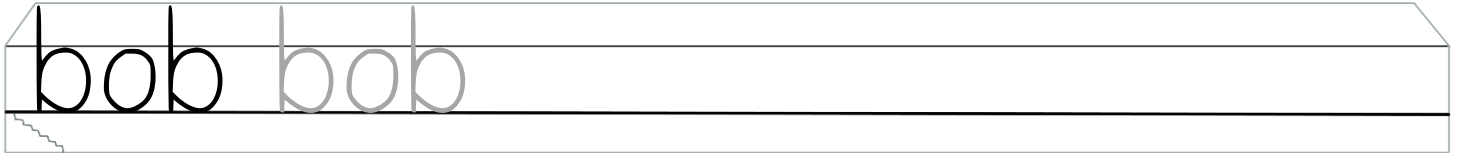
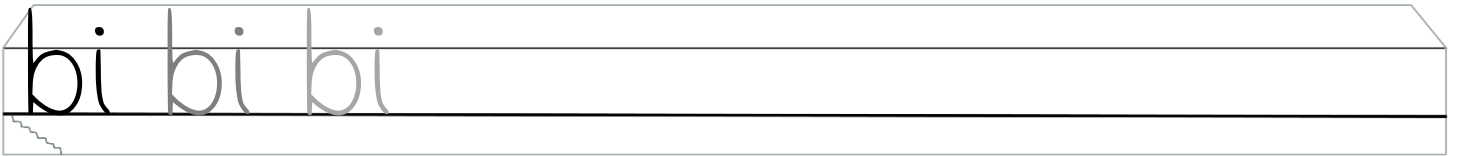
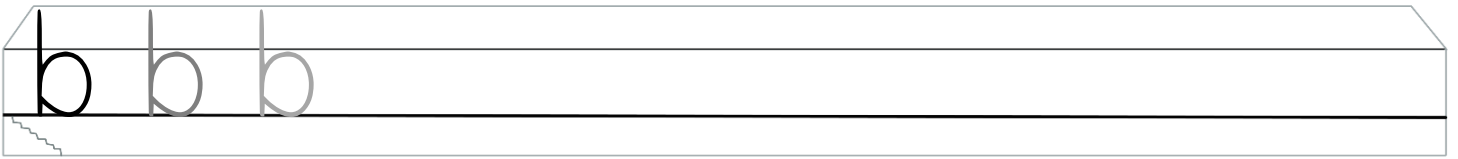

... og så det STORE

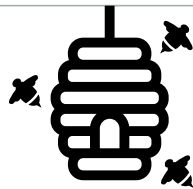

bikube

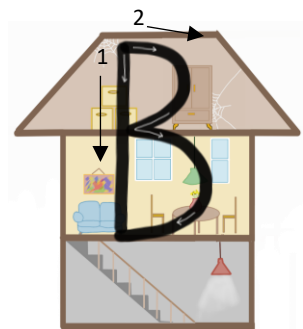
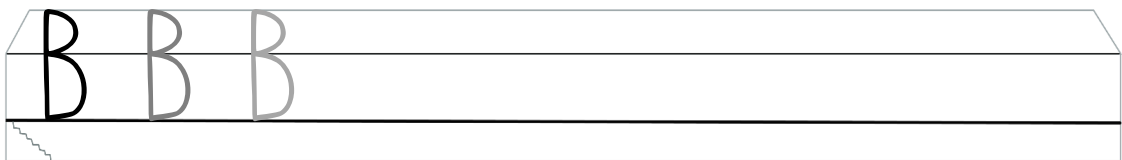

Du fortjener en stjerne, når din lærer har godkendt. Farv stjerne B i stjernesamlingen.



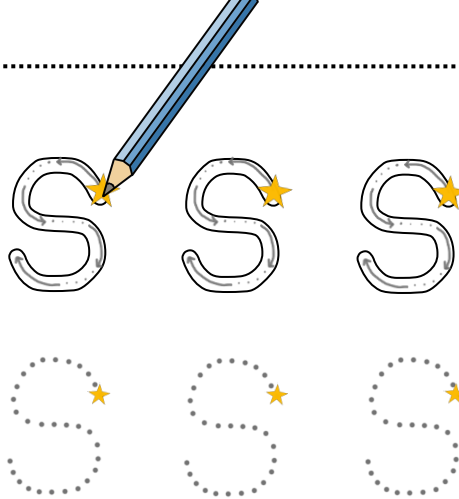
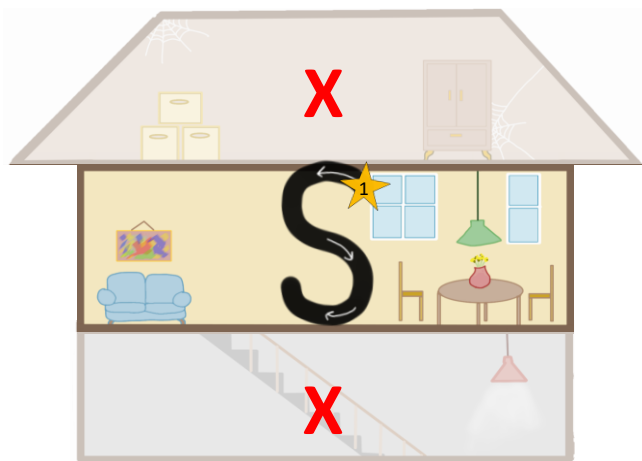

Skriv oven i bogstaverne her. Start ved stjernen.

Nu skal du skrive de flotteste s'er, du kan.

S S S

SO SO SO

SØS SØS

saks saks

sabel sabel

... og så det STORE



skildpadde

S S S



Du fortjener en stjerne, når din lærer har godkendt. Farv stjerne S i stjernesamlingen.



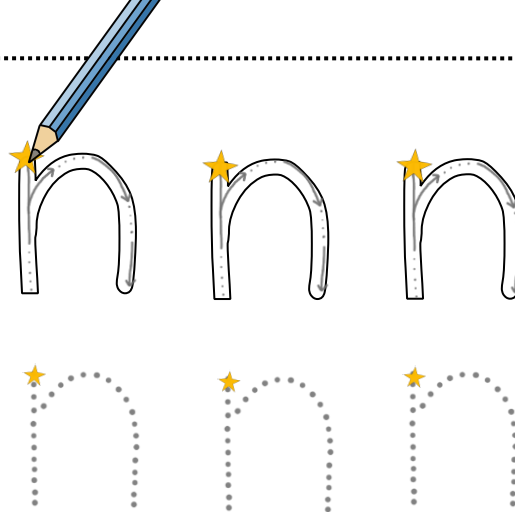
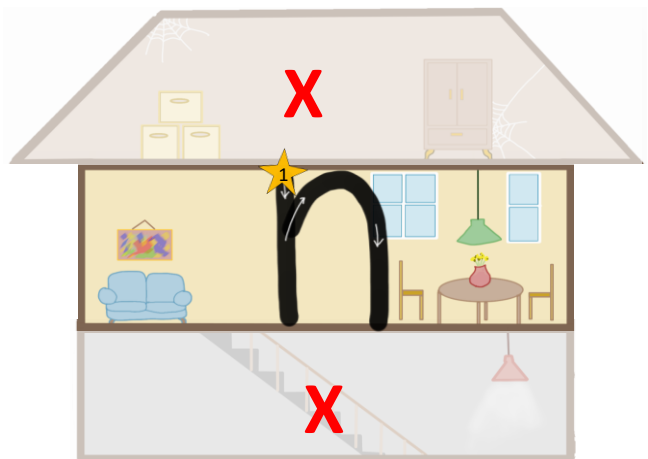

Skriv oven i bogstaverne her. Start ved stjernen.

Nu skal du skrive de flotteste n'er, du kan.

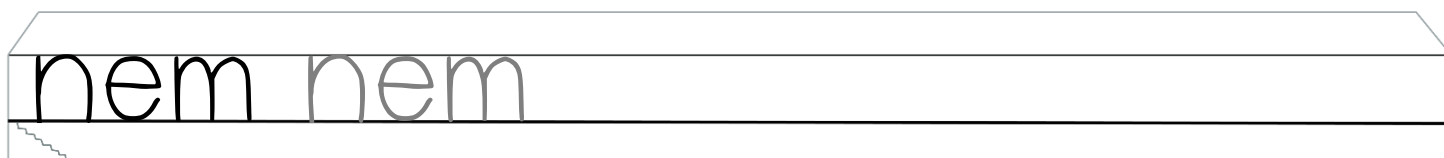
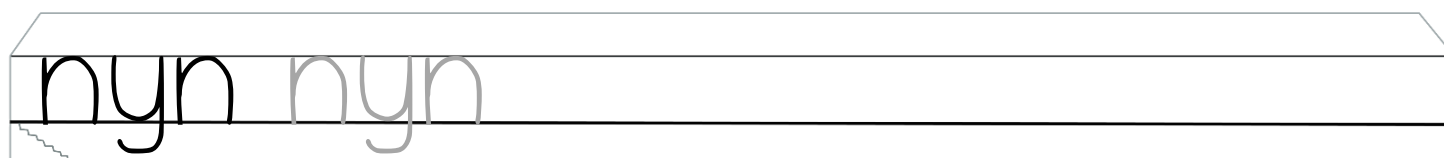
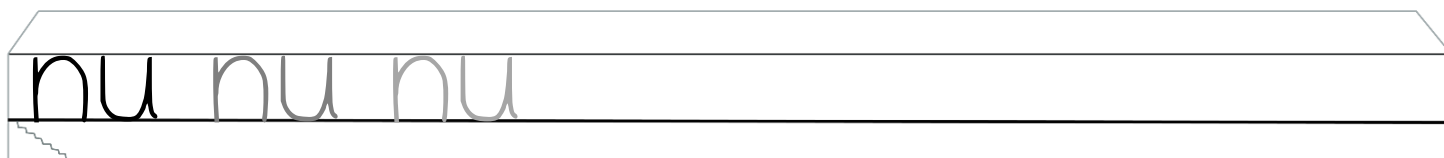
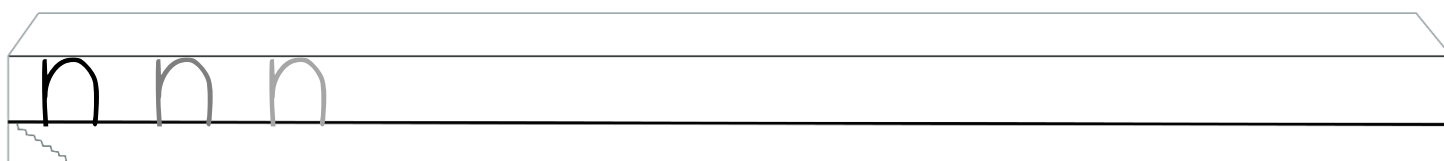

... og så det STORE



nasehorn

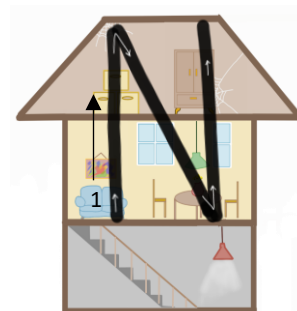
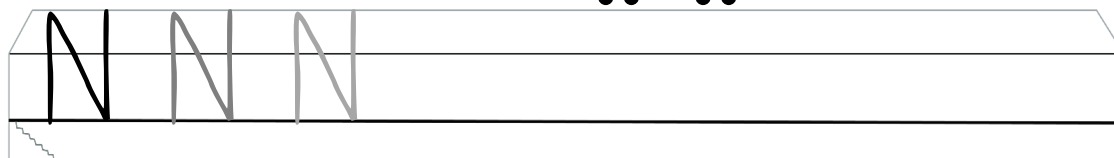

Du fortjener en stjerne, når din lærer har godkendt. Farv stjerne N i stjernesamlingen.



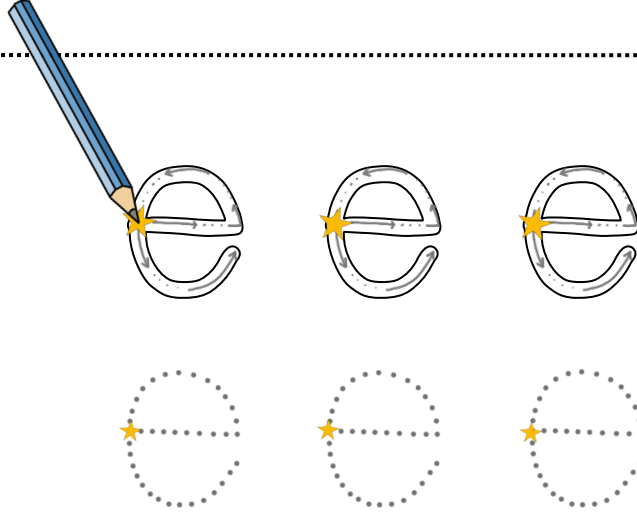
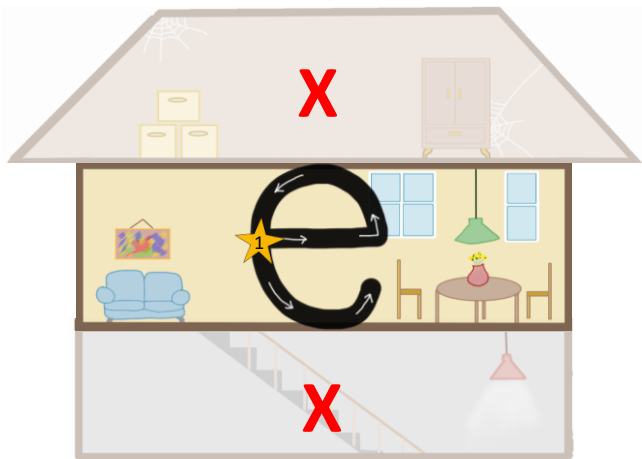

Skriv oven i bogstaverne her. Start ved stjernen.

Nu skal du skrive de flotteste e'er, du kan.

e e e

et et et

ene ene

elefant

Helene Helene

... og så det STORE

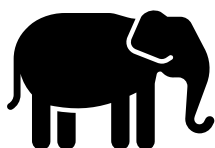

elefant

E E E

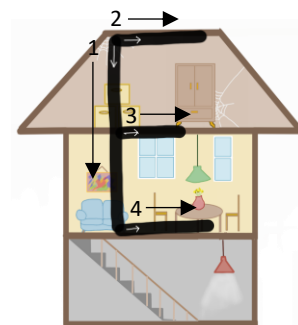

Du fortjener en stjerne, når din lærer har godkendt. Farv stjerne E i stjernesamlingen.



Øvelse gør mester 1

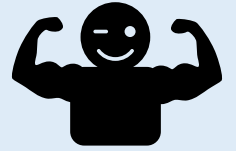

© opgaveskyen.dk

basen

bane

ben

ane

sne

bas

sene

æ



Du fortjener en stjerne, når din lærer har godkendt. Farv øve-stjerne 1 i stjernesamlingen.



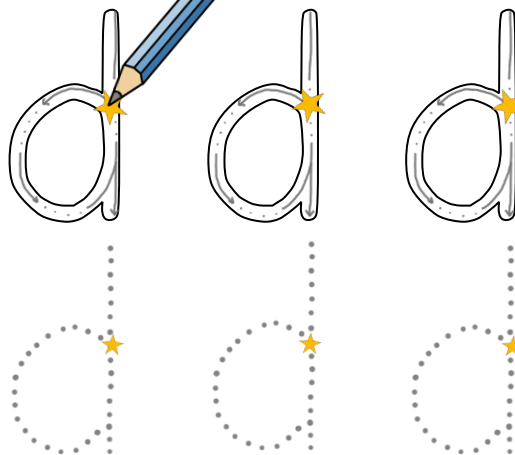
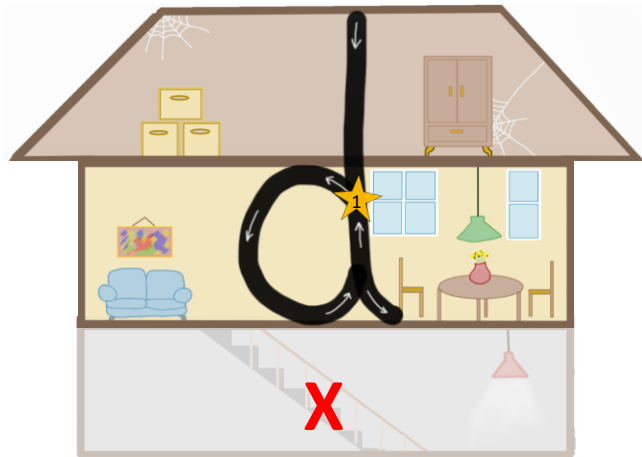

Skriv oven i bogstaverne her. Start ved stjernen.

Nu skal du skrive de flotteste d'er, du kan.

d d d

da da da

den den

dyd dyd

dans dans

... og så det STORE



danse

D D D

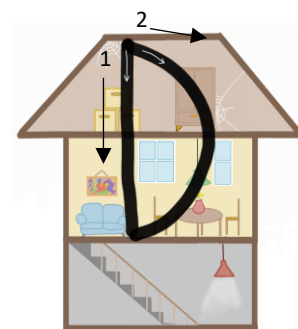

Du fortjener en stjerne, når din lærer har godkendt. Farv stjerne D i stjernesamlingen.



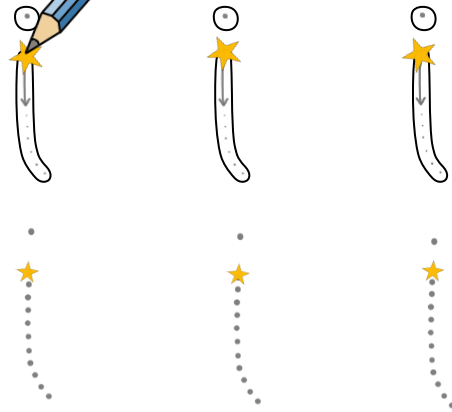
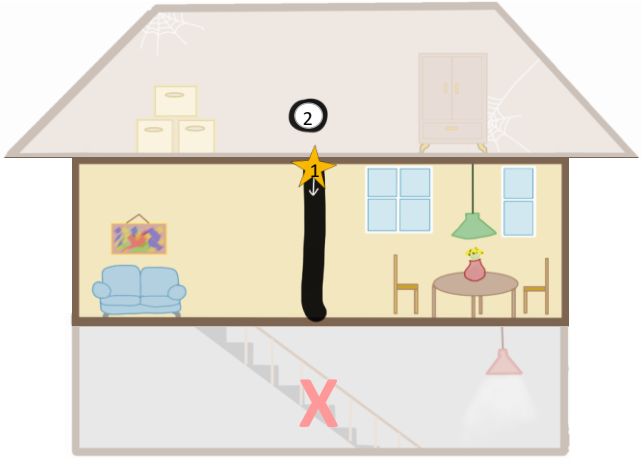

Skriv oven i bogstaverne her. Start ved stjernen.

Nu skal du skrive de flotteste i'er, du kan.

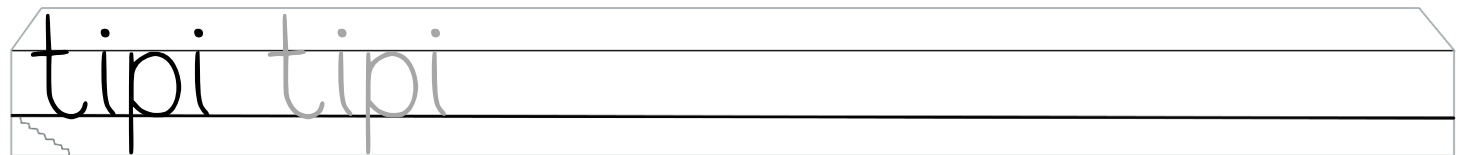
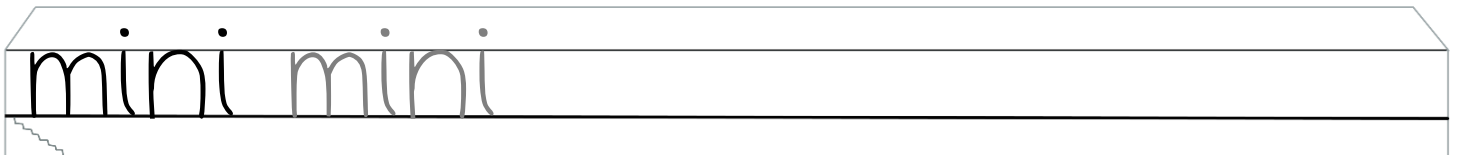
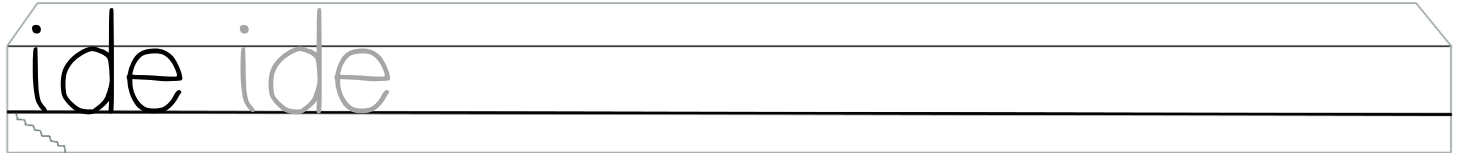
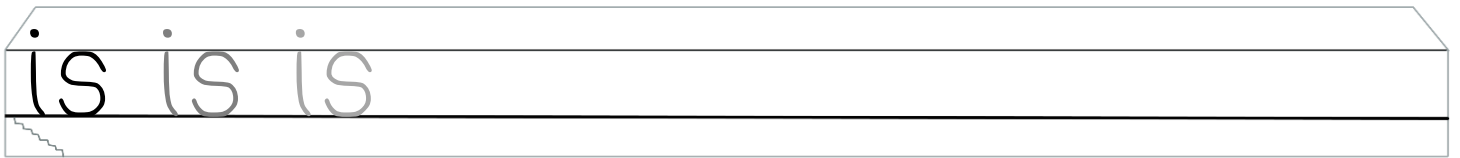
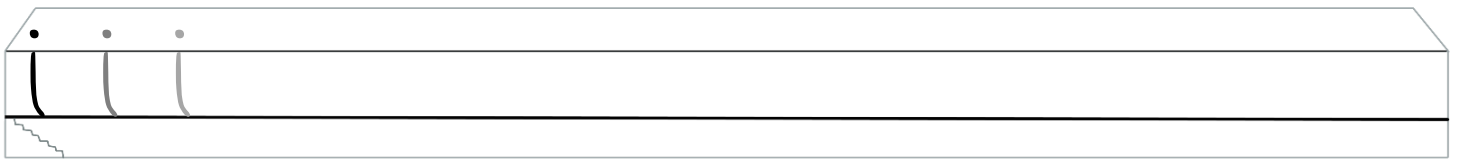

... og så det STORE

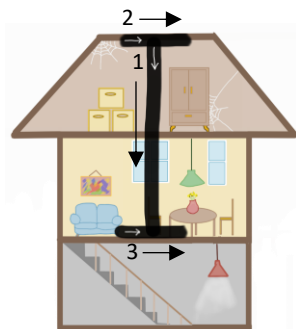
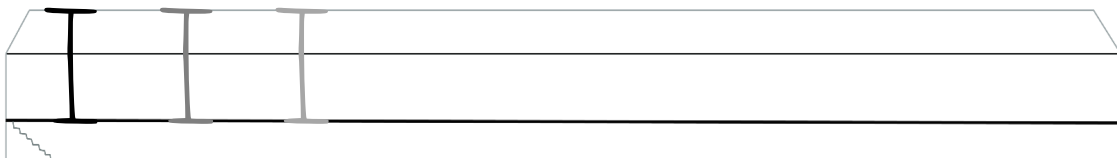

Du fortjener en stjerne, når din lærer har godkendt. Farv stjerne I i stjernesamlingen.



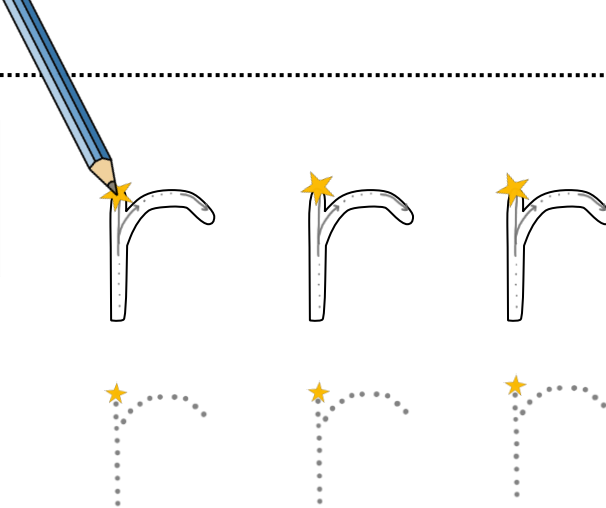

Skriv oven i bogstaverne her. Start ved stjernen.

Nu skal du skrive de flotteste r'er, du kan.

r r r

ru ru ru

ror ror

rar rar

herre herre

... og så det STORE

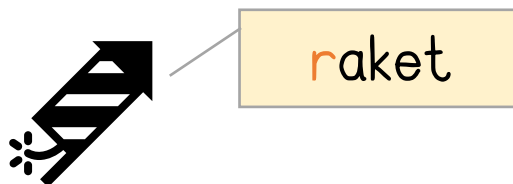

R R R

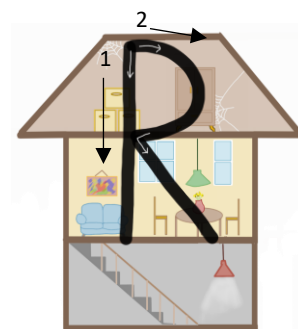

Du fortjener en stjerne, når din lærer har godkendt. Farv stjerne R i stjernesamlingen.



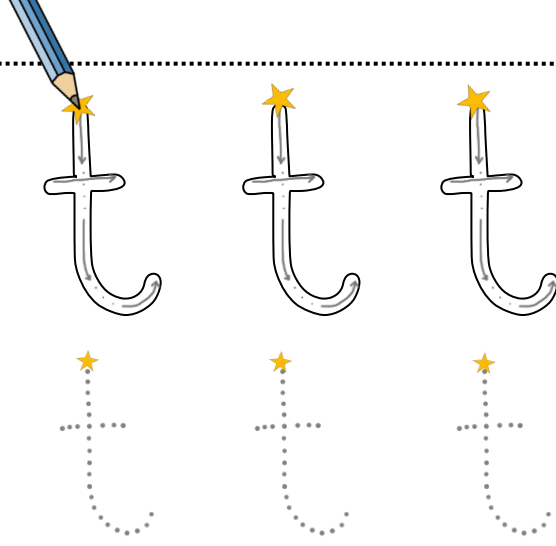
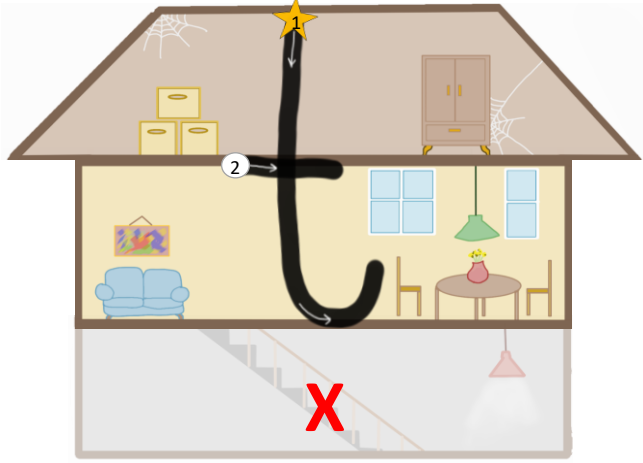

Skriv oven i bogstaverne her. Start ved stjernen.

Nu skal du skrive de flotteste t'er, du kan.

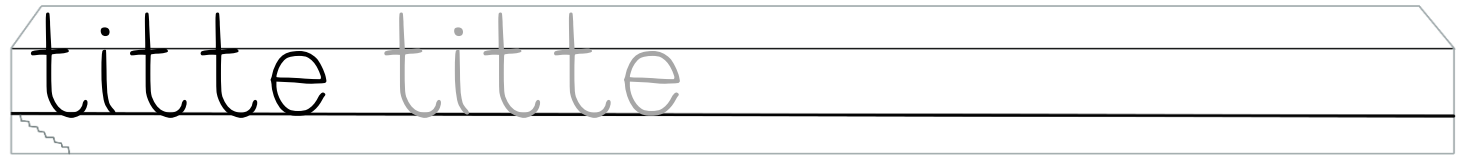
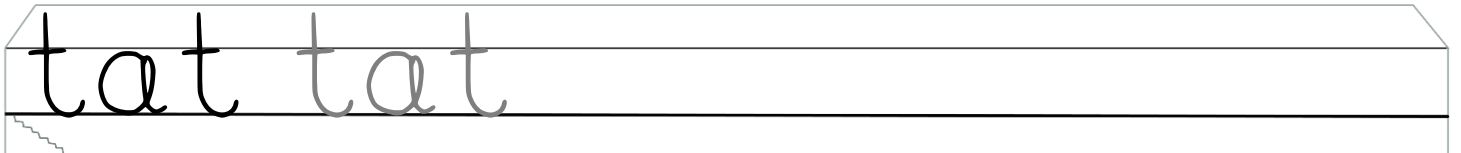
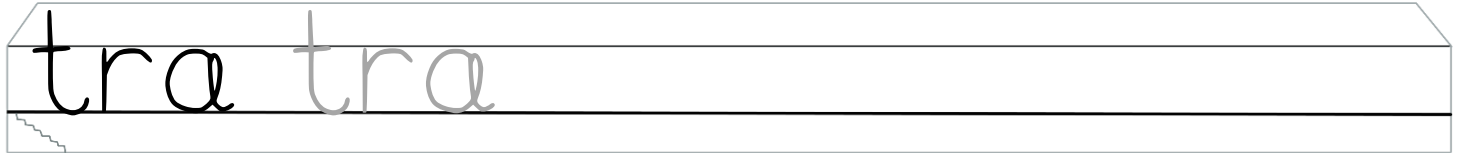
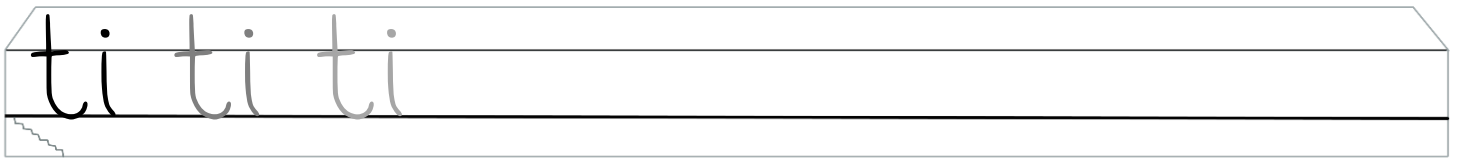
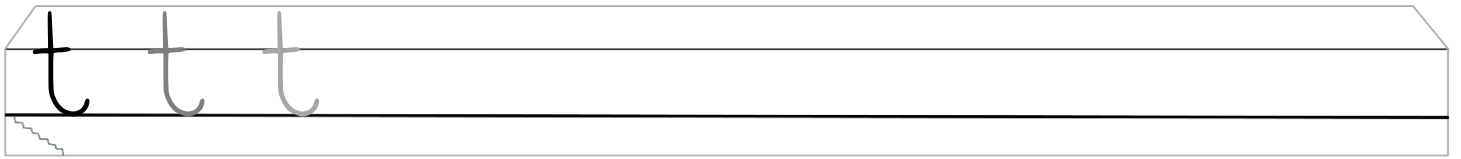

... og så det STORE

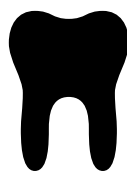

tand

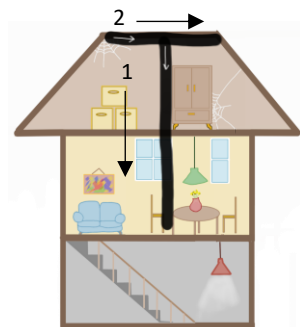
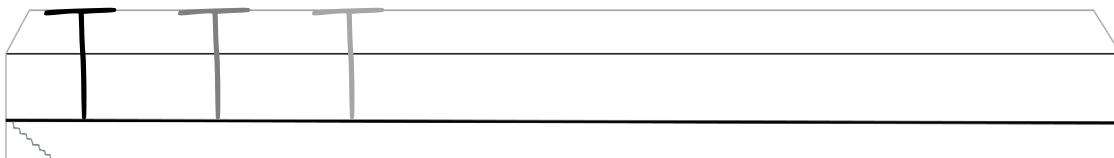

Du fortjener en stjerne, når din lærer har godkendt. Farv stjerne T i stjernesamlingen.



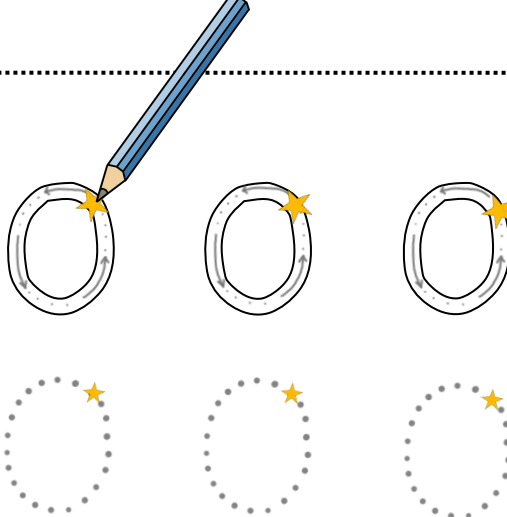
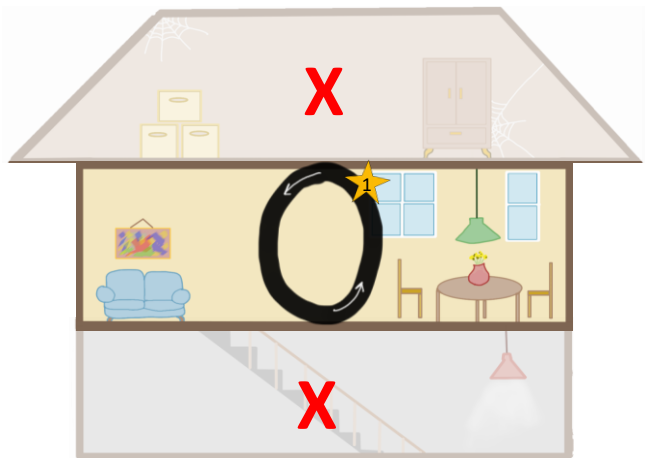

Skriv oven i bogstaverne her. Start ved stjernen.

Nu skal du skrive de flotteste o'er, du kan.

O O O

OS OS OS

obo obo

ZOO ZOO

robot robot

... og så det STORE



orm



O O O

Du fortjener en stjerne, når din lærer har godkendt. Farv stjerne O i stjernesamlingen.



Øvelse gør mester 2



© opgaveskyen.dk

to

tid

rid

rod

tro

trio

ro

ridt

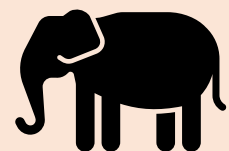
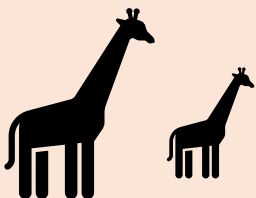

Du fortjener en stjerne, når din lærer har godkendt. Farv øve-stjerne 2 i stjernesamlingen.



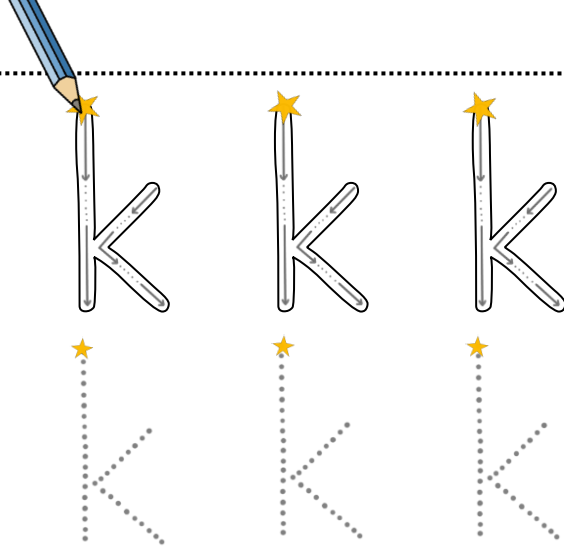
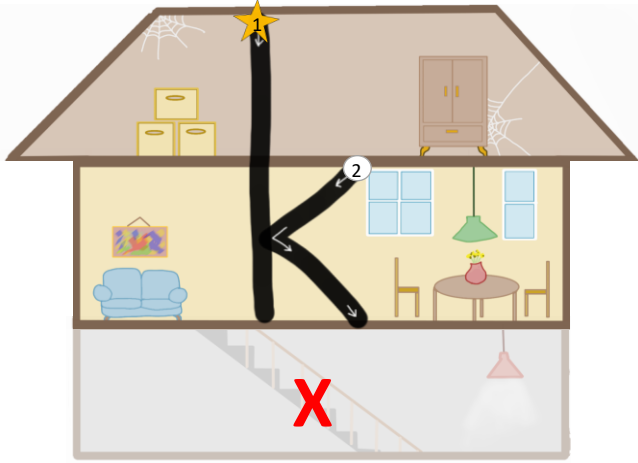

Skriv oven i bogstaverne her. Start ved stjernen.

Nu skal du skrive de flotteste k'er, du kan.

k k k

ko ko ko

kat kat

kok kok

kikkert kikkert

... og så det STORE

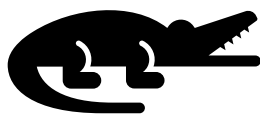

krokodille

K K K

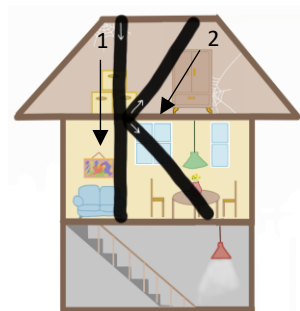

Du fortjener en stjerne, når din lærer har godkendt. Farv stjerne K i stjernesamlingen.



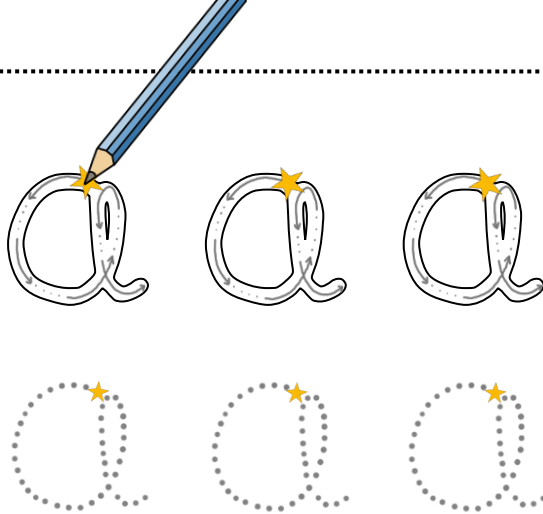

Skriv oven i bogstaverne her. Start ved stjernen.

Nu skal du skrive de flotteste æ'er, du kan.

æ æ æ

bar bar

able able

asel asel

lære lære

... og så det STORE



able

Æ Æ Æ

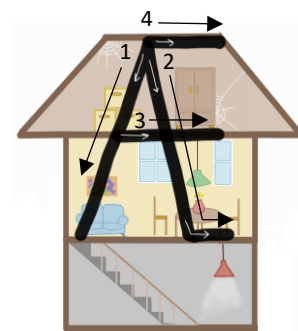

Du fortjener en stjerne, når din lærer har godkendt. Farv stjerne Æ i stjernesamlingen.



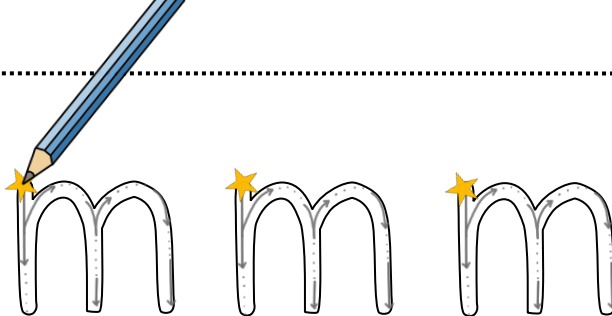
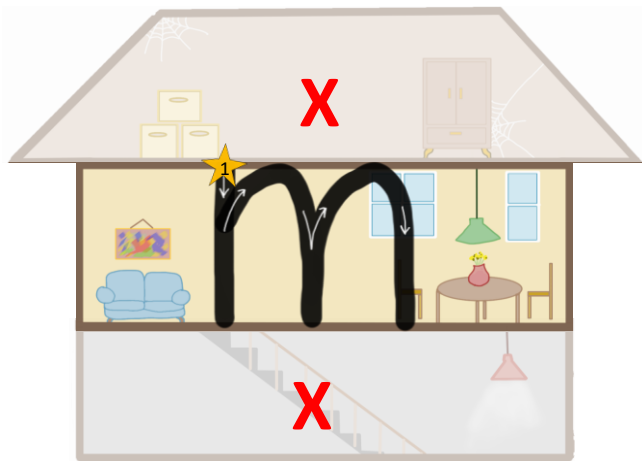

Skriv oven i bogstaverne her. Start ved stjernen.

Nu skal du skrive de flotteste m'er, du kan.

m m m

mis mis mis

mor mor

omme omme

mime mime

... og så det STORE



mus

M M M



Du fortjener en stjerne, når din lærer har godkendt. Farv stjerne M i stjernesamlingen.



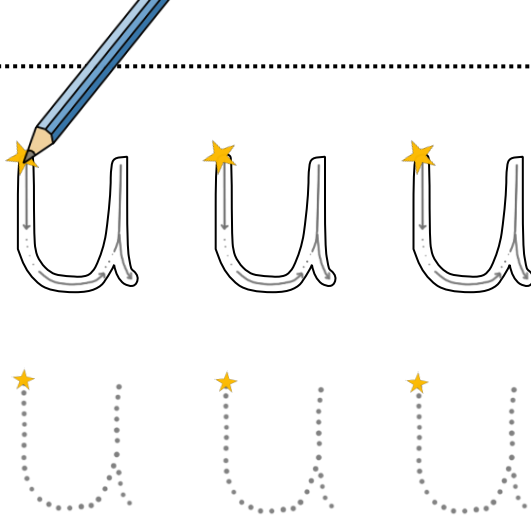
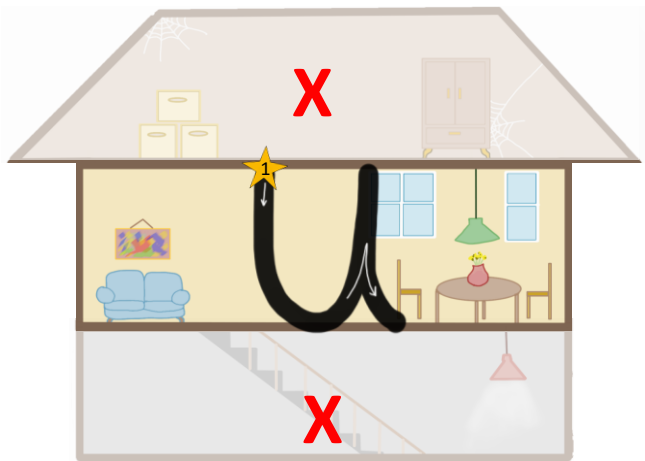

Skriv oven i bogstaverne her. Start ved stjernen.

Nu skal du skrive de flotteste u'er, du kan.

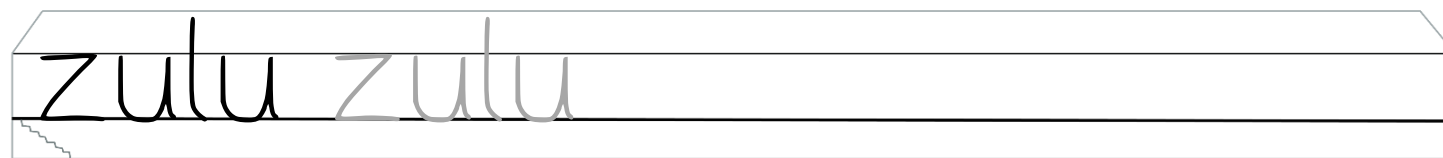
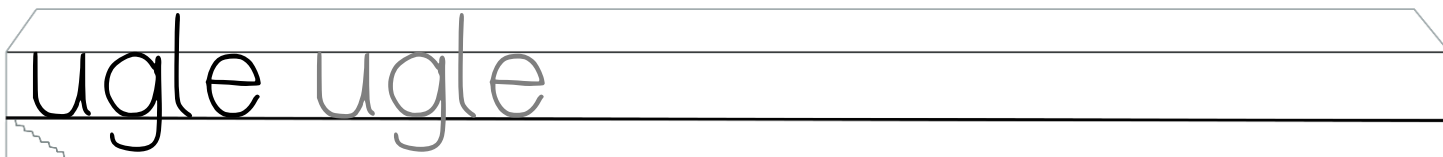
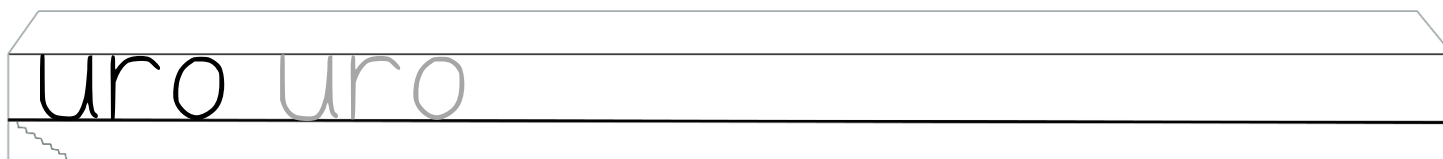
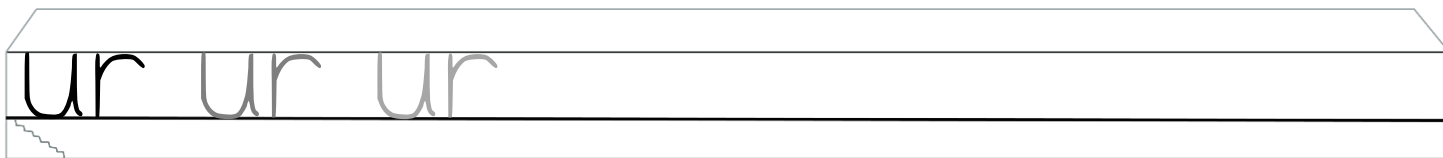
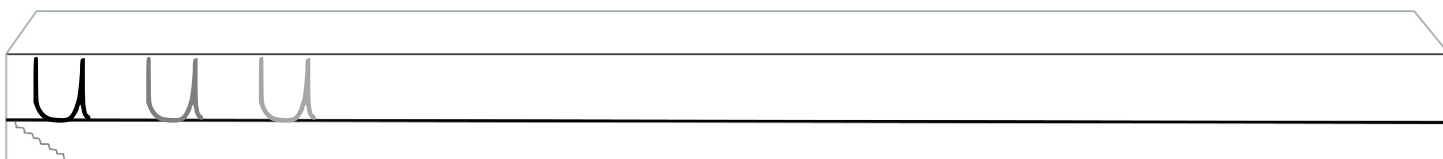

... og så det STORE



ugle

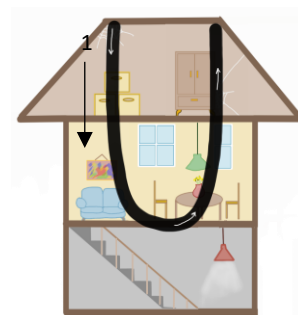
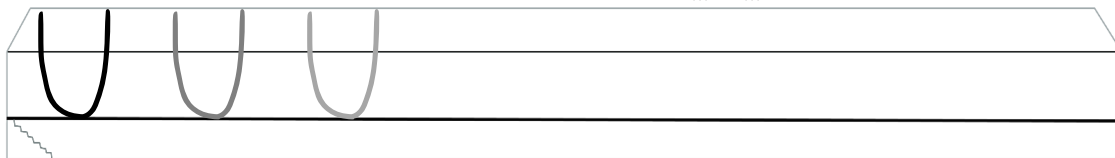

Du fortjener en stjerne, når din lærer har godkendt. Farv stjerne U i stjernesamlingen.



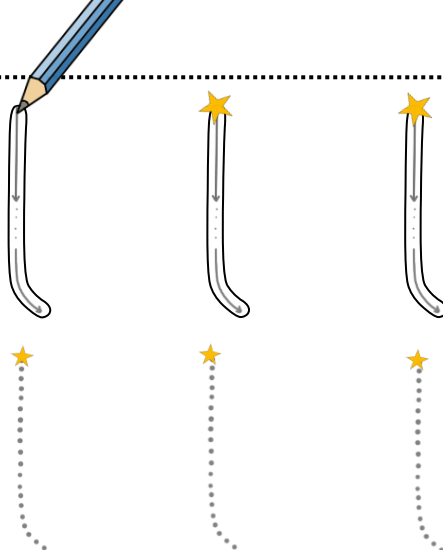
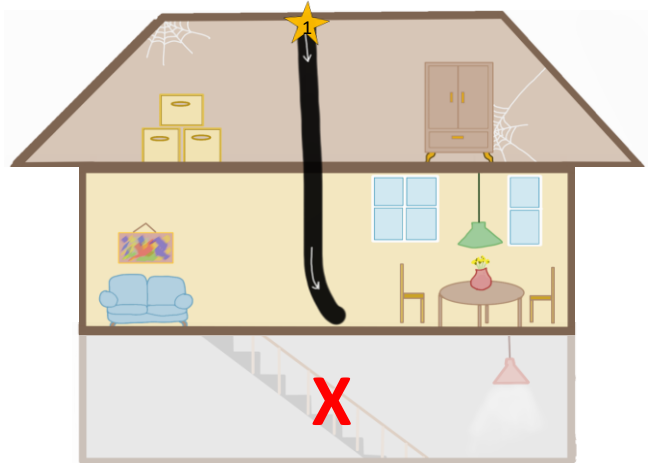

Skriv oven i bogstaverne her. Start ved stjernen.

Nu skal du skrive de flotteste l'er, du kan.

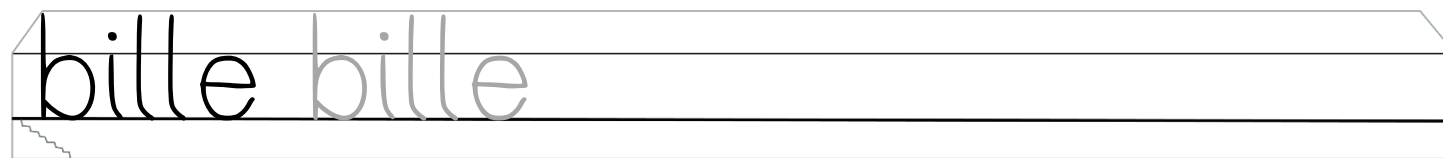
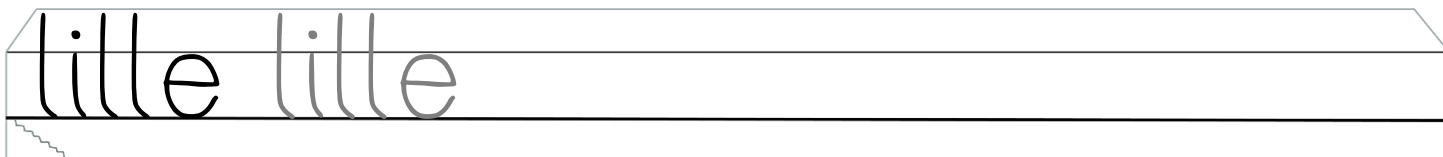
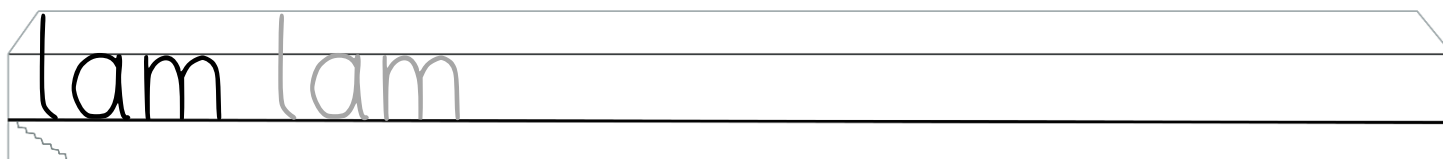
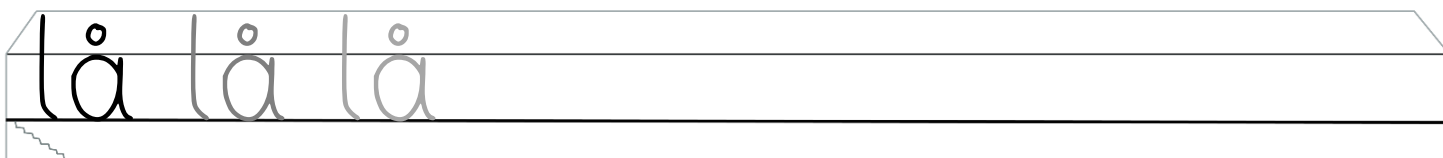
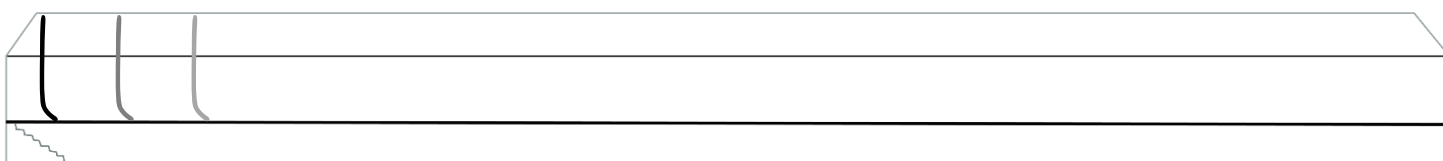

... og så det STORE



lampe

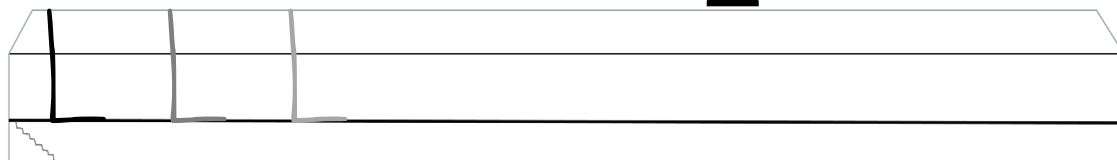

Du fortjener en stjerne, når din lærer har godkendt. Farv stjerne L i stjernesamlingen.



Øvelse gør mester 3



© opgaveskyen.dk

køl

læ

kul

malk

kalk

luk

læk

ulk



Du fortjener en stjerne, når din lærer har godkendt. Farv øve-stjerne 3 i stjernesamlingen.



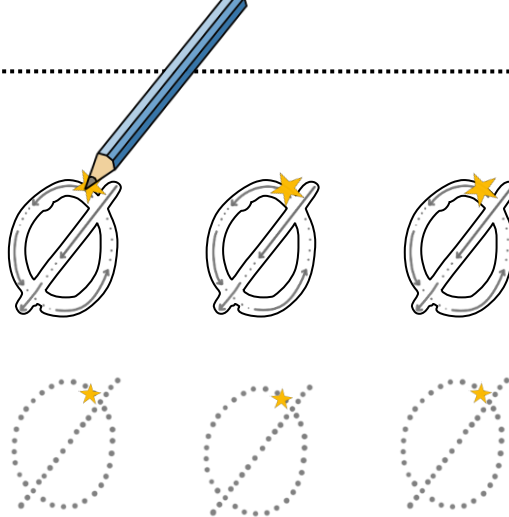
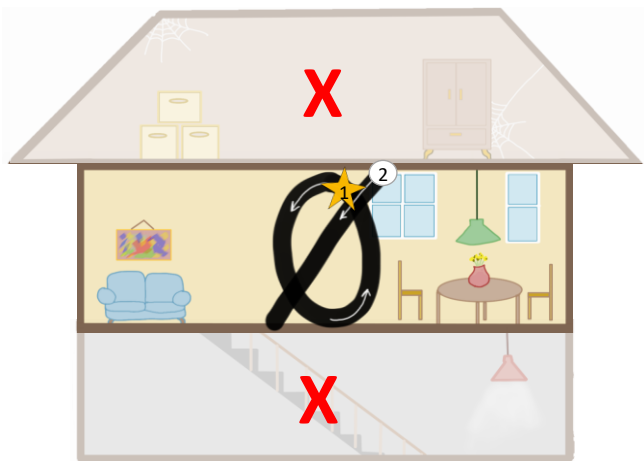

Skriv oven i bogstaverne her. Start ved stjernen.

Nu skal du skrive de flotteste ø'er, du kan.

Ø Ø Ø

øl øl øl

øve øve

høre høre

ønske ønske

... og så det STORE



Ø Ø Ø

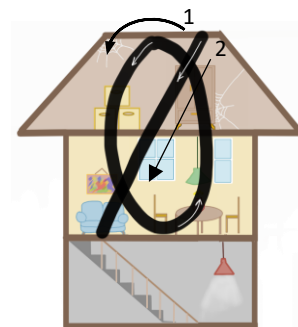

Du fortjener en stjerne, når din lærer har godkendt. Farv stjerne Ø i stjernesamlingen.



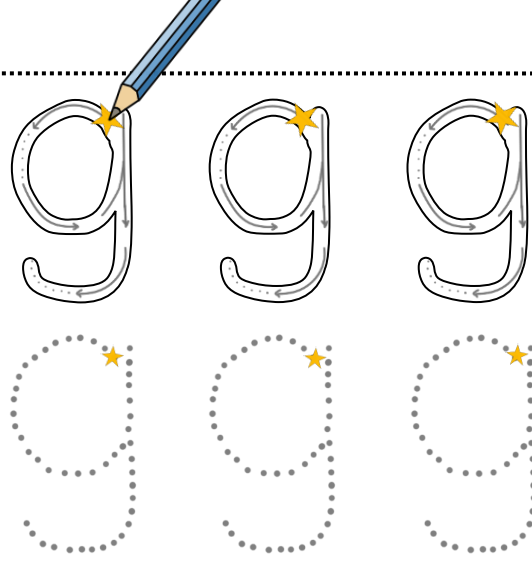
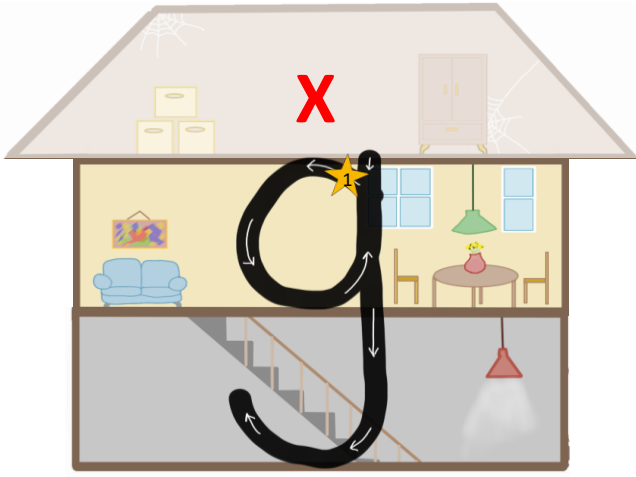

Skriv oven i bogstaverne her. Start ved stjernen.

Nu skal du skrive de flotteste g'er, du kan.

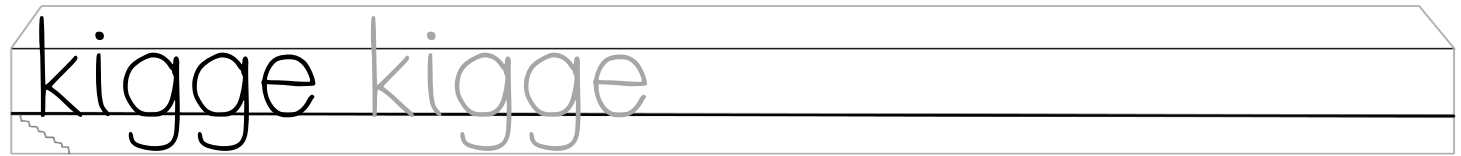
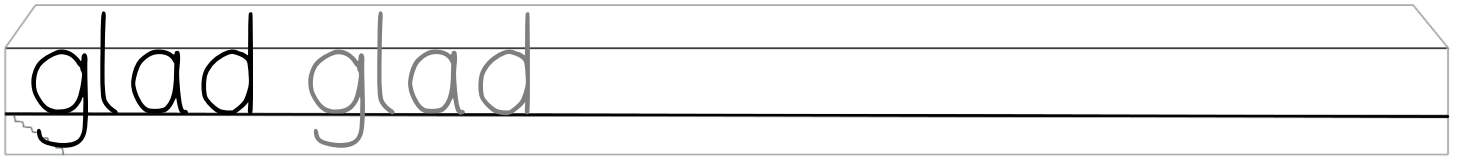
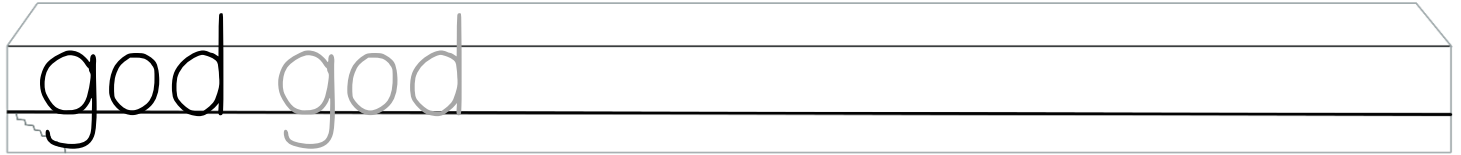
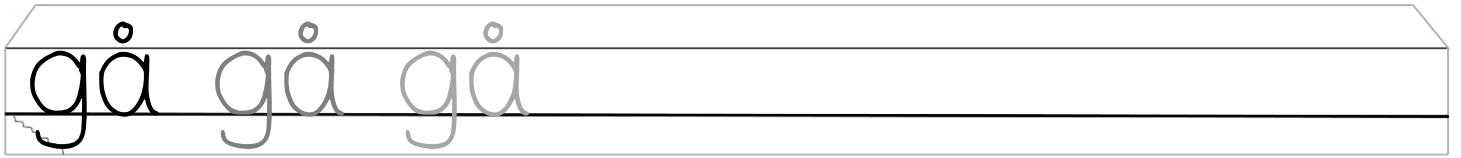
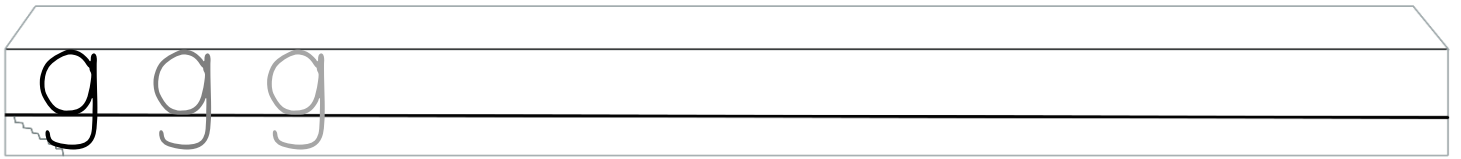

... og så det STORE



giraf

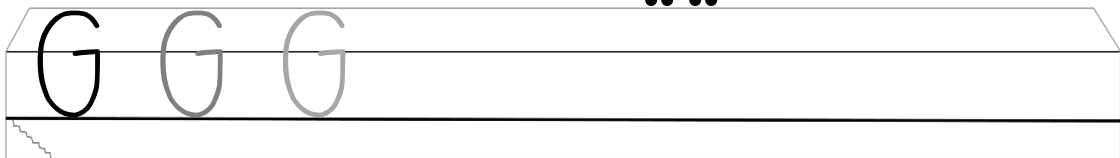

Du fortjener en stjerne, når din lærer har godkendt. Farv stjerne G i stjernesamlingen.



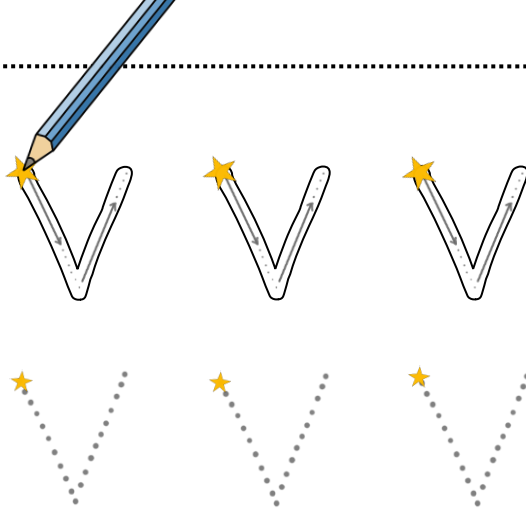
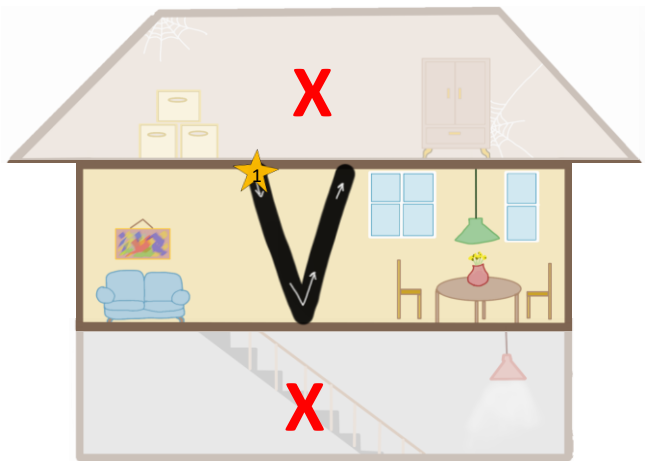

Skriv oven i bogstaverne her. Start ved stjernen.

Nu skal du skrive de flotteste v'er, du kan.

v v v

vi vi vi

ven ven

vove vove

vare vare

... og så det STORE



vanter

V V V

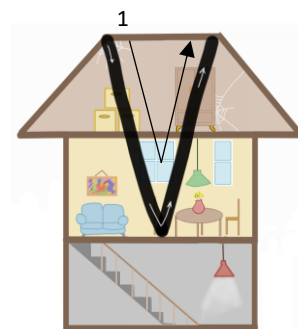

Du fortjener en stjerne, når din lærer har godkendt. Farv stjerne V i stjernesamlingen.



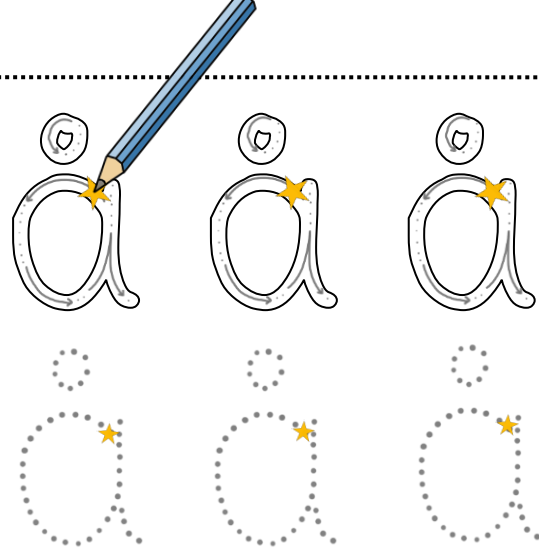

Skriv oven i bogstaverne her. Start ved stjernen.

Nu skal du skrive de flotteste å'er, du kan.

å å å

ål ål ål

lås lås

både både

åben åben

... og så det STORE



ål

Å Å Å

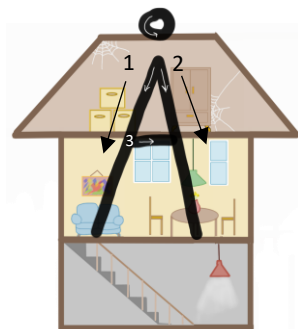

Du fortjener en stjerne, når din lærer har godkendt. Farv stjerne Å i stjernesamlingen.



Øvelse gør mester 4

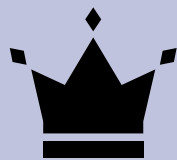

© opgaveskyen.dk

øg

gå

gø

hø

våg

høg

gøg

åh

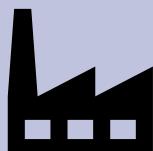

Du fortjener en stjerne, når din lærer har godkendt. Farv øve-stjerne 4 i stjernesamlingen.

4

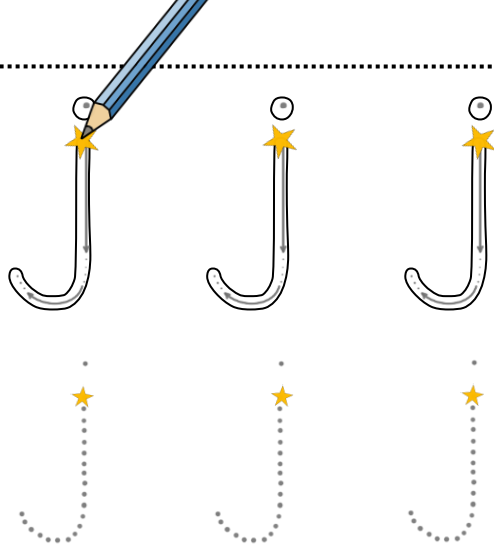

Skriv oven i bogstaverne her. Start ved stjernen.

Nu skal du skrive de flotteste j'er, du kan.

j j j

ja ja ja

jul jul

jeg jeg

juvel juvel

... og så det STORE



juletra

J J J



Du fortjener en stjerne, når din lærer har godkendt. Farv stjerne J i stjernesamlingen.



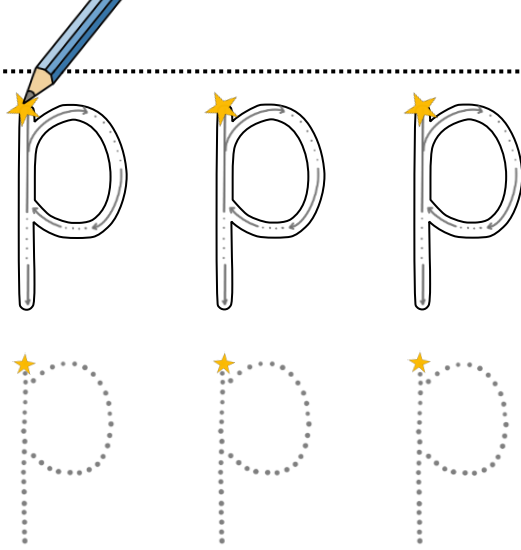
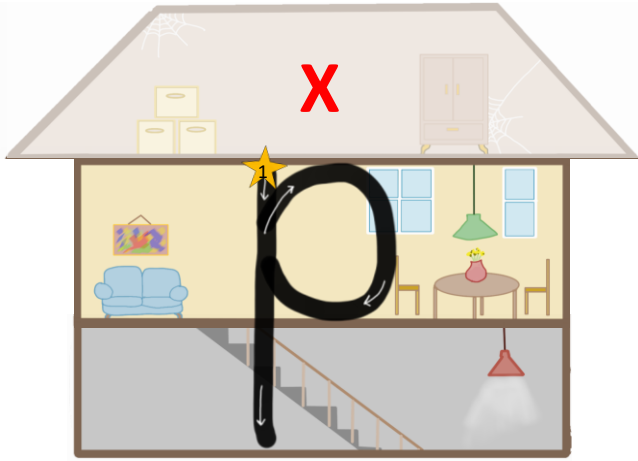

Skriv oven i bogstaverne her. Start ved stjernen.

Nu skal du skrive de flotteste p'er, du kan.

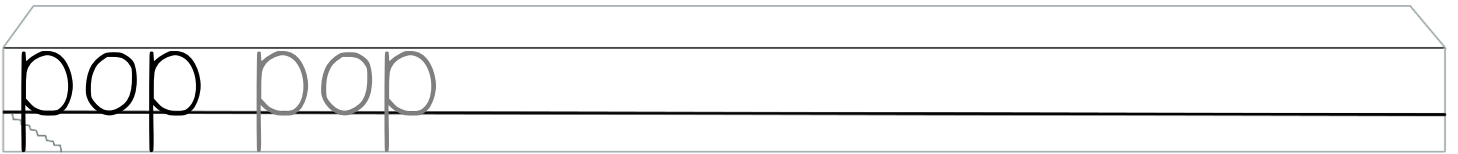
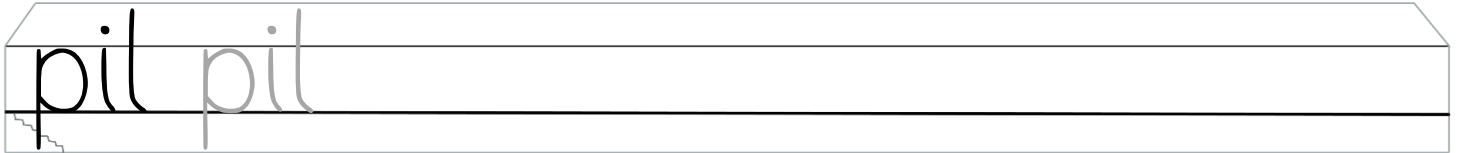
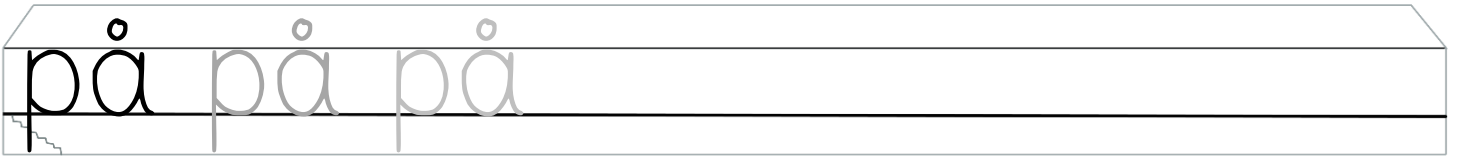
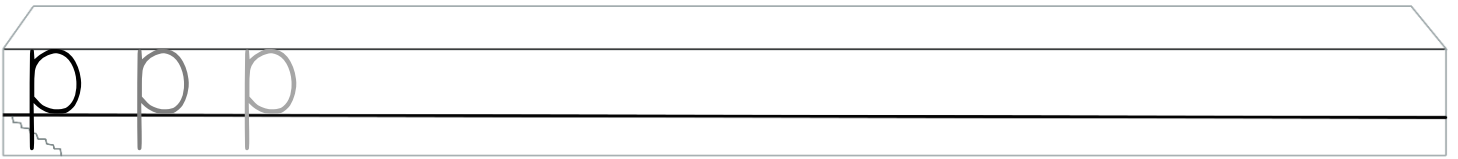

... og så det STORE

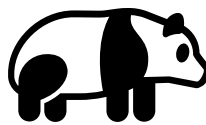

panda

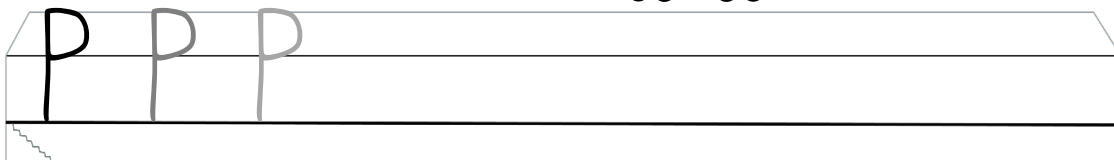

Du fortjener en stjerne, når din lærer har godkendt. Farv stjerne P i stjernesamlingen.



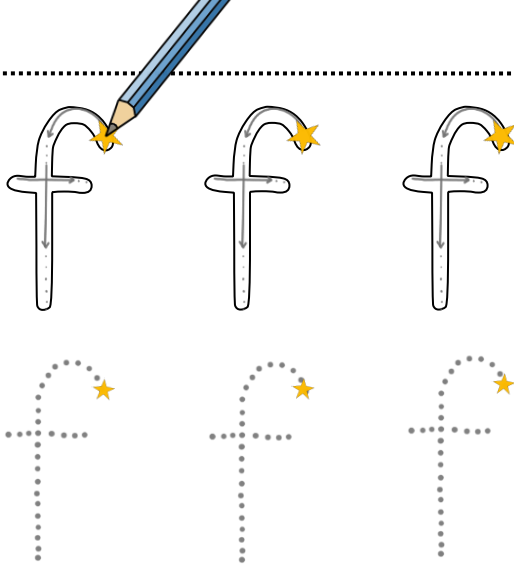
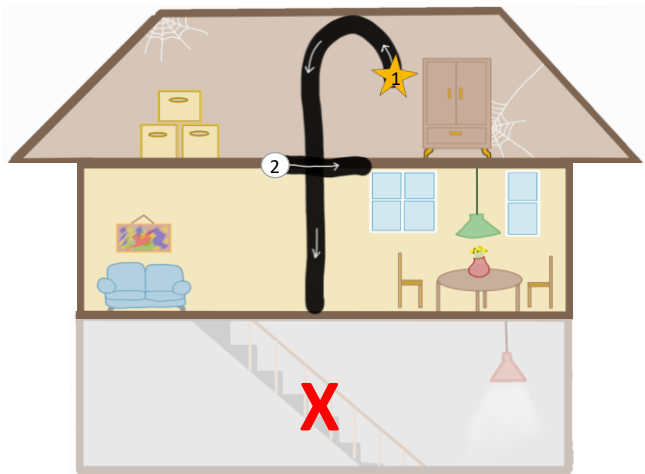

Skriv oven i bogstaverne her. Start ved stjernen.

Nu skal du skrive de flotteste f'er, du kan.

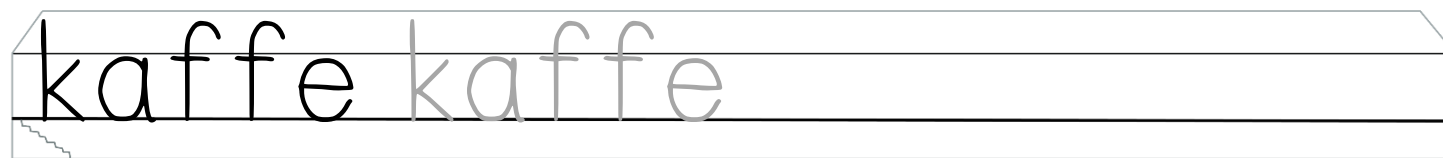
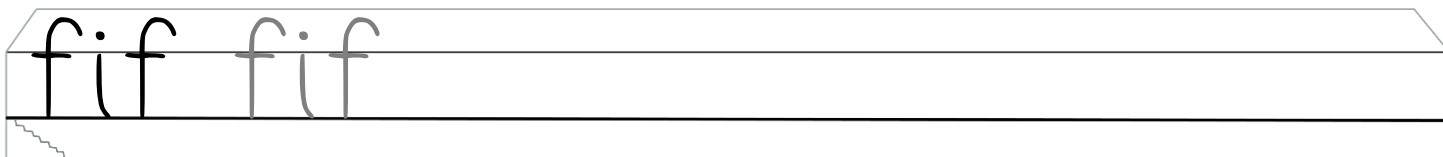
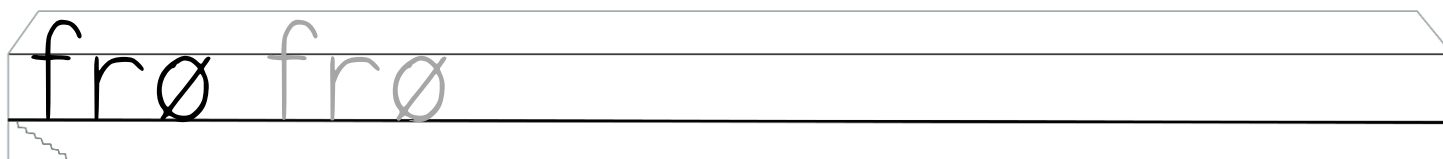
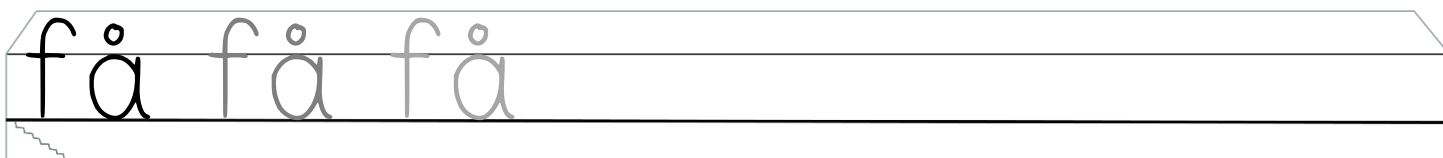
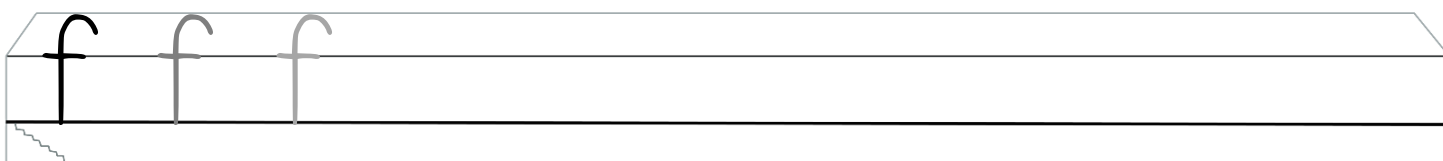

... og så det STORE

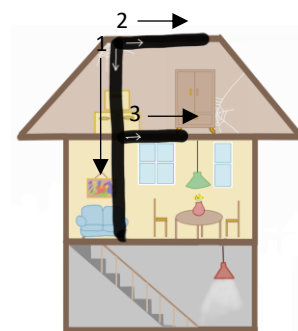
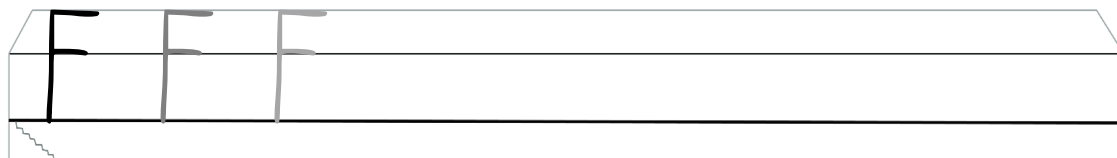
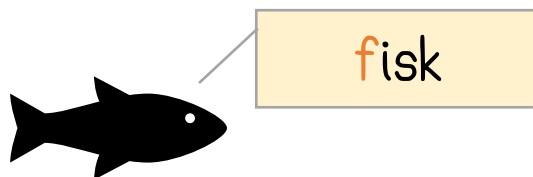

Du fortjener en stjerne, når din lærer har godkendt. Farv stjerne F i stjernesamlingen.



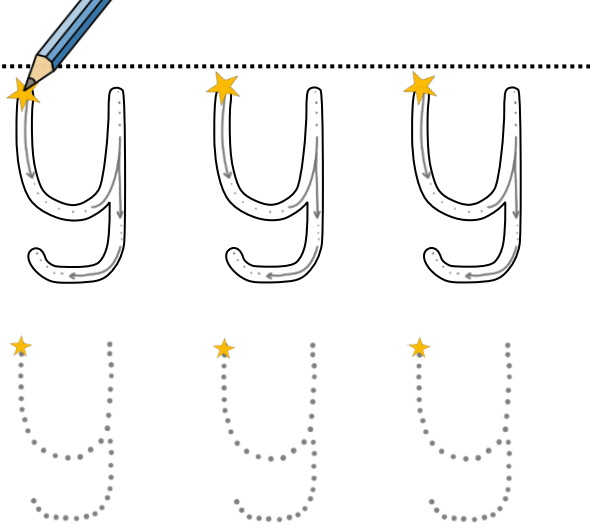
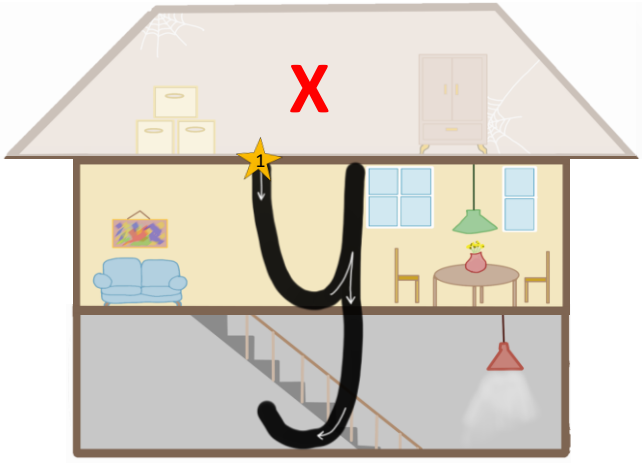

Skriv oven i bogstaverne her. Start ved stjernen.

Nu skal du skrive de flotteste y'er, du kan.

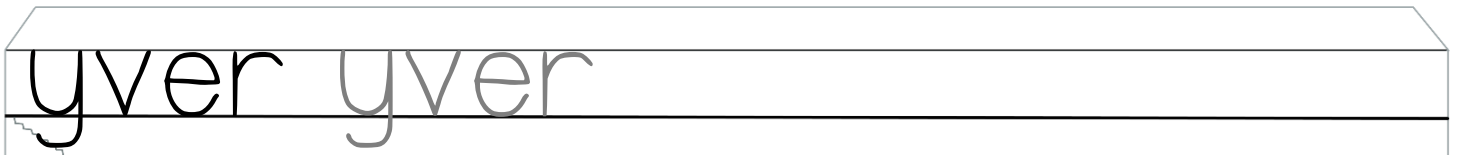
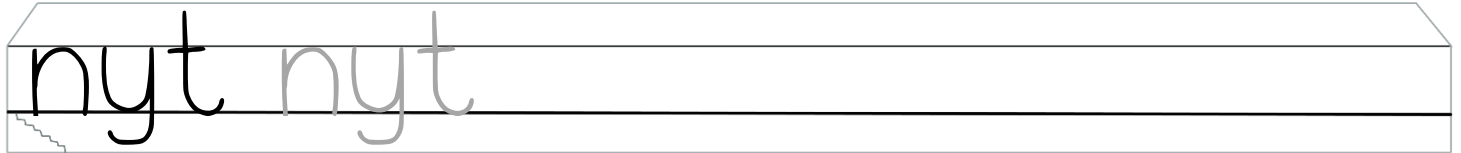
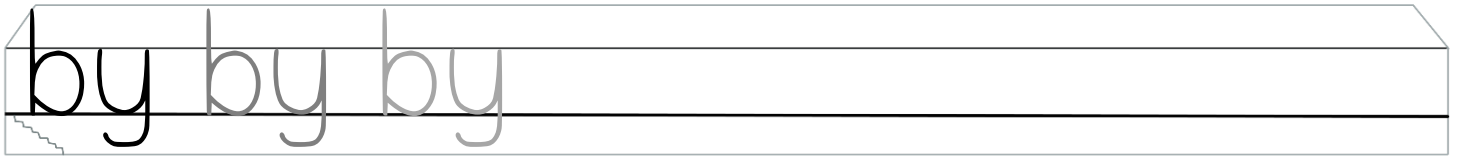
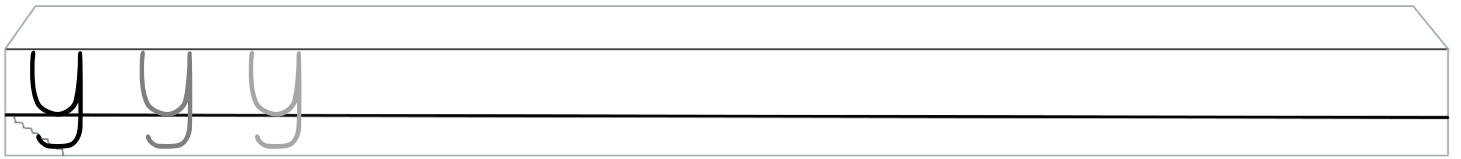

... og så det STORE



yver

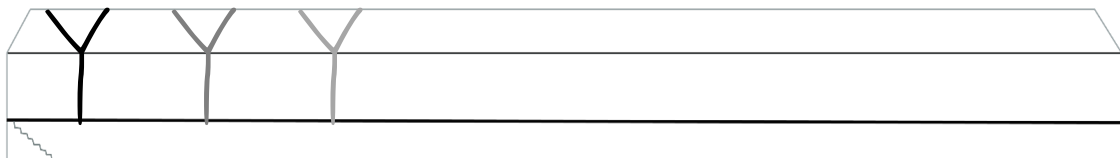
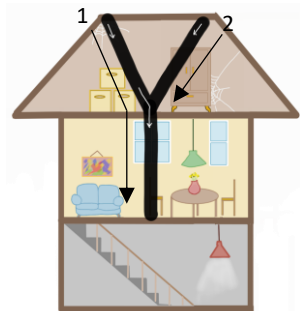

Du fortjener en stjerne, når din lærer har godkendt. Farv stjerne Y i stjernesamlingen.



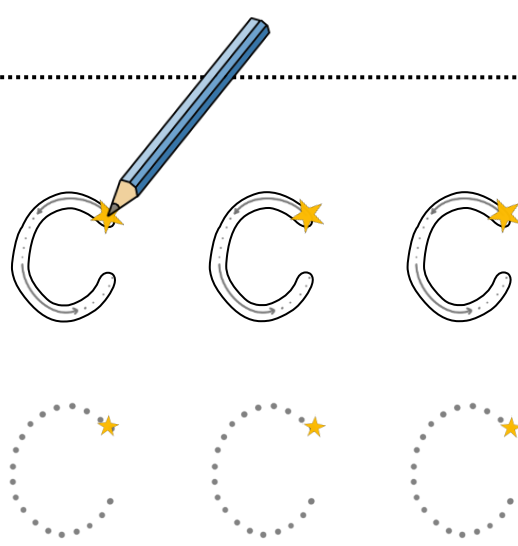
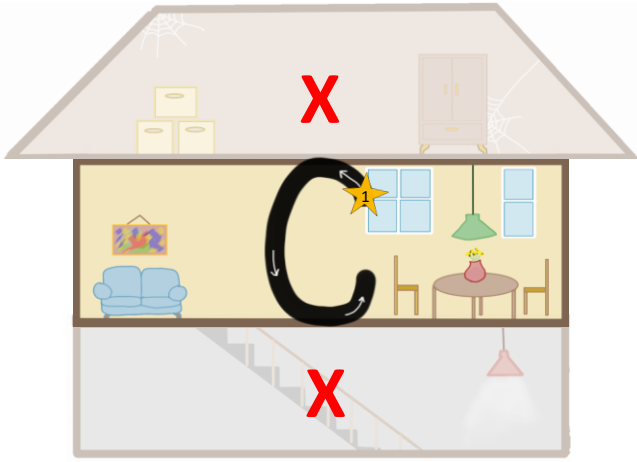

Skriv oven i bogstaverne her. Start ved stjernen.

Nu skal du skrive de flotteste c'er, du kan.

C C C

cd cd cd

cafe cafe

cykel cykel

citron citron

... og så det STORE



cykel



C C C

Du fortjener en stjerne, når din lærer har godkendt. Farv stjerne C i stjernesamlingen.



Øvelse gør mester 5



© opgaveskyen.dk

fy

pyt

fyg

myg

fej

pap

hyp

føj

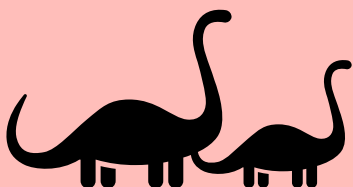

Du fortjener en stjerne, når din lærer har godkendt. Farv øve-stjerne 5 i stjernesamlingen.



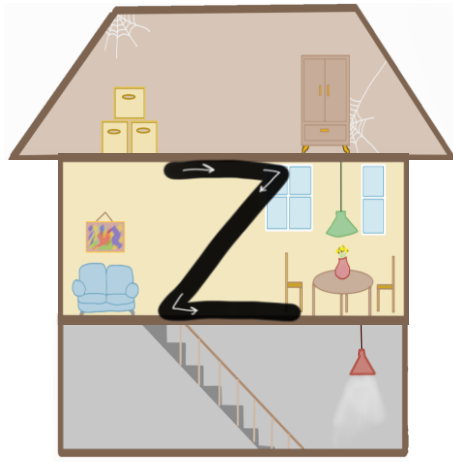
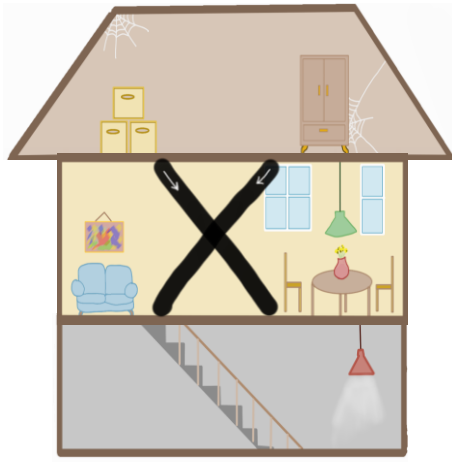

Nu skal du skrive de flotteste q'er, x'er og z'er, du kan.

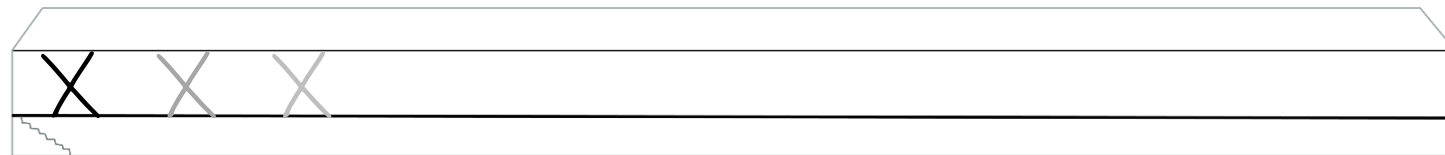
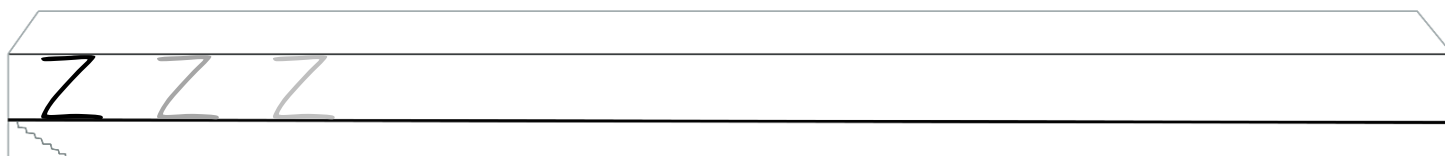
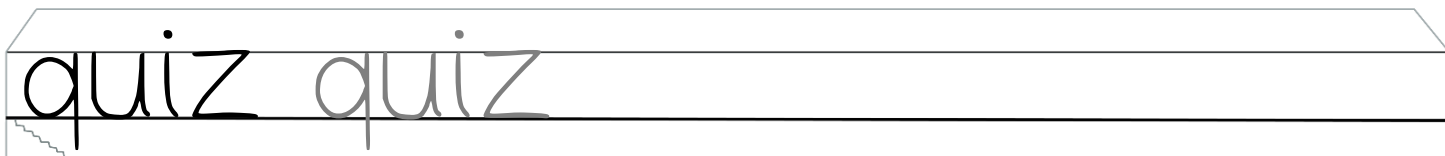
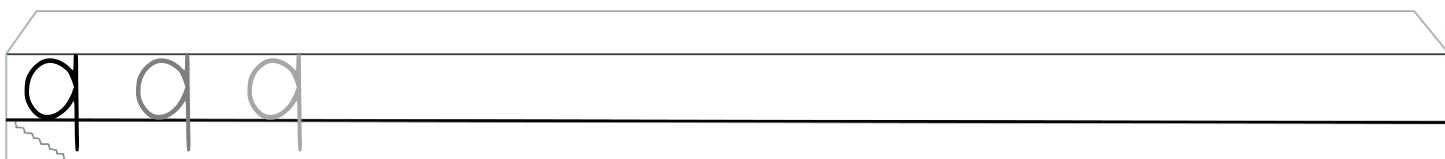

... og så det STORE

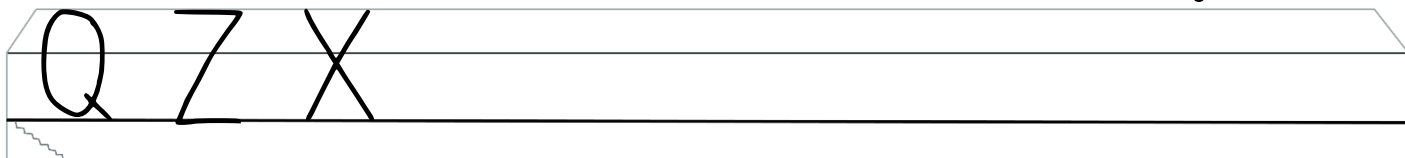
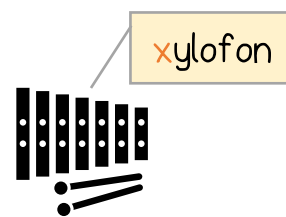
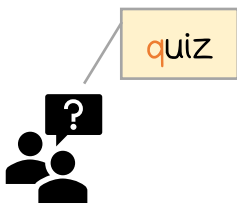



GODT GÅET!

Farv de stjerner, som du har optjent.



ØVELSE GØR MESTER



